

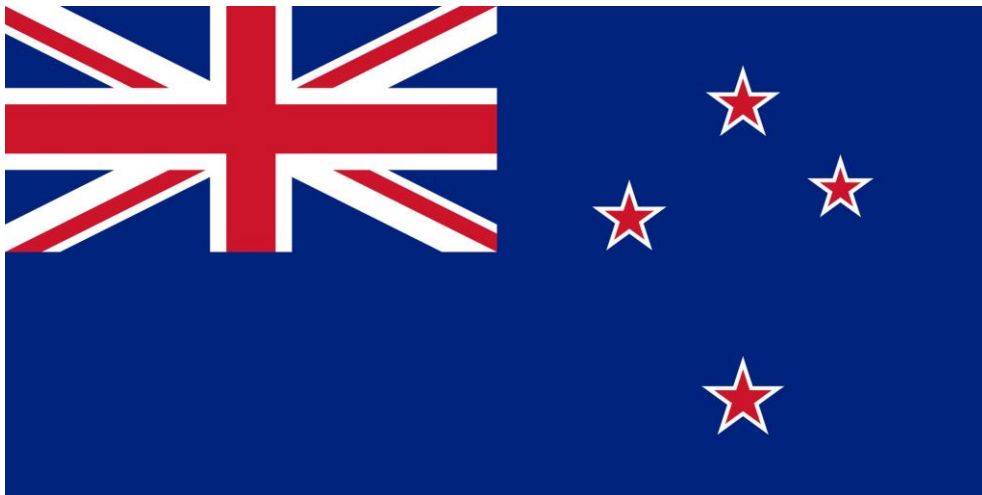

The Leon Morel Catalogue of Medallic Commemoratives of New Zealand up to 1940:

The 1900s



Chapter Editors: Martin Purdy, Jason Gray, Rodney Hall, and Hamish MacMaster

RNSNZ © 2020 - 2023

New Series (2022) Version 1. Last Updated: 2023-Nov-08

ISBN 978-1-99-110855-5

The Leon Morel Catalogue of Medalllic Commemoratives of New Zealand up to 1940:
The 1900s

ISBN

- 1 978-1-99-110855-5 (November 2023)
- 2 978-1-99-110856-2
- 3 978-1-99-110857-9
- 4 978-1-99-110858-6
- 5 978-1-99-110859-3

Martin Purdy FRNSNZ
Jason Gray
Rodney Hall
Hamish MacMaster FRNSNZ

Copyright © RNSNZ and the contributing editors, 2023

This work is freely distributable in electronic form and is not intended for sale or resale, either electronically or in hard copy. Please acknowledge the RNSNZ when sharing.

Download the latest version from
www.RNSNZ.org.nz/collector-info/catalogues

Royal Numismatic Society of New Zealand Inc.
PO Box 2023
Wellington 6140
New Zealand

Autobiographical Note



Leon with members of the "Starlets" coin club in 1966 (NZ Numismatic Journal no. 42)

My introduction to numismatics was at school when I swapped a box of marbles for WW1 coins. This small group of coins fascinated me and led me to visit the Canterbury Museum's large collection many times.

Fortunately a custodian suggested I contact Ernie Dale who was Chairman of a Society who could help me. He certainly did and I joined the Canterbury Branch of the RNSNZ and enjoyed many years in the company of informative speakers who widened my knowledge. I am forever grateful to the members of the Canterbury society.

The introduction of decimal currency in 1967 resulted in a surge in sales of New Zealand sterling coins at inflated prices, which led me to advertise price lists at what I considered more sensible levels.

New Zealand medallions were plentiful and, in 1950, with the issue of the Canterbury Centennial medal, I started collecting medallions in earnest which eventually led to the issue of a small catalogue in 1976, and later, as new items were found, a much expanded and illustrated second edition (1996) and a supplement (2000).

I also purchased a small, lovely collection of Edward VIII Coronation medallions, which grew into a very large collection. Many friendships resulted, including Richard Lobel of Coincraft, who has an amazing collection.

Autobiographical Note

Banknotes became an interest when I discovered the Reserve Bank of New Zealand would sell notes direct to collectors, a great service which has sadly been discontinued.

We retired to Melbourne, where our four sons resided, in 2000. So I packed my accumulation into 120 special containers which Customs officials were interested in, but released them when they realised it was my private collection.

I am delighted that the team will update “Medallic Commemoratives New Zealand 1865-1940”.

My congratulations and appreciation.

Leon G Morel FRNSNZ (2016)



2006 anniversary event, at which Leon Morel (left) was the longest-standing RNSNZ member (joined 1950) and Ray Staal (right) the longest-standing WCC member present (joined 1966)

Note by the compilers (2020): Leon gave his agreement to our updating his catalogue to include more recent discoveries during his visit to the RNSNZ Convention in 2014. Work began almost immediately on digitising the text of his 1996 Catalogue and 2000 Supplement, as well as logging new discoveries and gathering photos of existing items. This activity has continued in the background ever since, though it has only been with the upheavals to normal work routines brought about by Covid-19 that we have had the opportunity to start putting it into its final shape.

Leon died in late 2019 at the age of 87, and we are saddened not only by the loss of someone who put such a huge effort into documenting and promoting New Zealand commemorative medals, but also by the fact that he did not live to see the release of the revised 3rd edition of his magnum opus.

Contents

Autobiographical Note	3
Contents	5
Introduction.....	7
Acknowledgements.....	9
Bibliography.....	11
Amendments & Updates to 1996/2000 Edition	15
Commemorative Medals – Issues of the 1900s	17
List of Makers & Manufacturers.....	165
Rarity Scale	169
About the Authors	171
Notes / New Additions	175
The End.....	176

Introduction

The Leon Morel Catalogue of Medallic Commemoratives of New Zealand up to 1940:

The 1900s

Martin Purdy FRNSNZ
Jason Gray
Rodney Hall
Hamish MacMaster FRNSNZ

ISBN 978-1-99-110855-5

This is part of a projected multi-volume series updating Leon Morel's Catalogue of Medallic Commemoratives of New Zealand, 1865-1940 (1996) and the Supplement published in 2000. This new edition marks a departure from previous RNSNZ catalogue projects in that it is being released electronically in the first instance, and in sections. In this way, parts of the book can be published as they become ready and can also be regularly updated as new information becomes available.

The various sections of the catalogue will ultimately cover the whole of NZ's medallic history from the earliest issues associated with this country through to the Centennial events of 1940. More recent issues, from 1940 (not Centennial-related) to date, are being covered by a companion series, "New Zealand Commemorative Medals since 1940, New Series (2022)", also being published in parts and in electronic form.

Because these publications are being released as searchable PDFs, the previous Index of Legends has now been dispensed with as unnecessary.

Acknowledgements

Special thanks to the late Leon Morel for entrusting us with this project and supplying much original reference material.

Thanks to the many dealers and collectors who have made illustrations available, including Lewis Barton, Cardiff Rugby Museum, Tony Grant, Phil Horne, Jim Noble, Jim Johnson, Ross and Angie Kidd, Craig Kitchen, Don MacNeill, Mowbray Collectables, Museum of New Zealand Te Papa Tongarewa, the New Zealand Rugby Museum, and many others whom we have approached with specific requests since beginning this project in 2014. Special thanks also to the late Malcolm Johnson (Australia) for making available his research into oddball NZ items. It would not have been possible without their generous assistance.

Version no.: 1, November 2023

**Please advise the authors of any new discoveries, or any errors or omissions detected.
Contact email: martin_lists@yahoo.com**

SOUVENIR MEDALS issued at the Exhibition Mint,

By **STOKES & SONS**, for the N. Z. I. Exhibition, 1906-7.

Nos. 1, 2, 3, 4, also Crosses and Map of N.Z., 1/- each, warranted to wear like gold
 Nos. 1, 2, 3, in Sterling Silver, 3/-, 2/-, & 1/6 each, Crosses 2/- each.

Orders by Post promptly attended to.



Postcard advertising medals made by Stokes for the NZ International Industrial Exhibition, Christchurch, 1906-1907 (see 1906-07/3 – 1906-07/59)

Bibliography

NZ Medals:

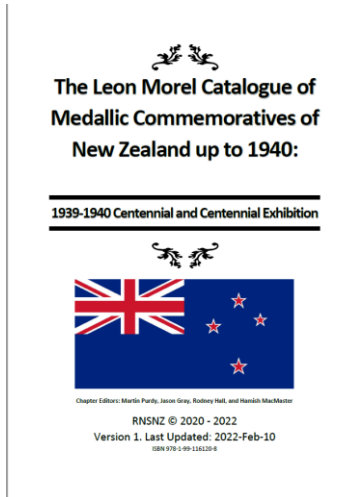

Purdy M, Gray J,
Hall R, MacMaster H

Medallic
Commemoratives of
New Zealand
Up To 1940
(New series, 2022)
© RNSNZ 2022
PDFs by chapter:

[www.RNSNZ.org/
collector-
info/catalogues](http://www.RNSNZ.org/collector-info/catalogues)



Morel L G

Medallic
Commemoratives
of New Zealand
1865-1940
(Supplement to
2nd edition)

© LGM 2000



Morel L G

Medallic
Commemorative
of New Zealand
1865-1940
(2nd edition)

© LGM 1996

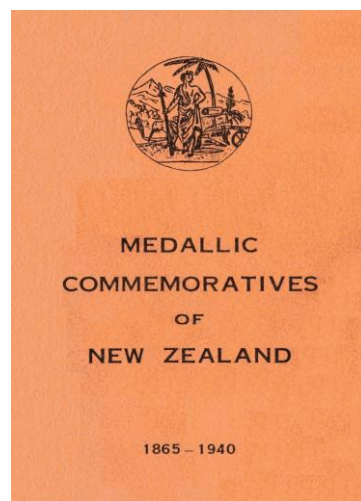

Morel L G

Medallic
Commemorative
of New Zealand
1865-1940
(1st edition)

© LGM 1976

New Zealand Commemorative Medals – 1900s

Bibliography



Purdy M, Gray J,
Hall R, MacMaster H

New Zealand
Commemorative
Medals Since 1940
(New series, 2022)

(PDF Only By Decade)

© RNSNZ 2022

ISBN
978-1-99-110810-4

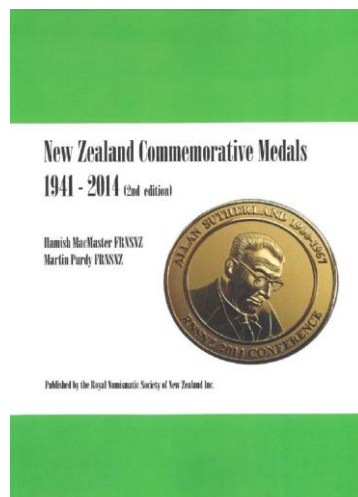

MacMaster H &
Purdy M

New Zealand
Commemorative
Medals 1941-2014
(2nd edition)

© RNSNZ 2014

ISBN
978-0-473-28731-3

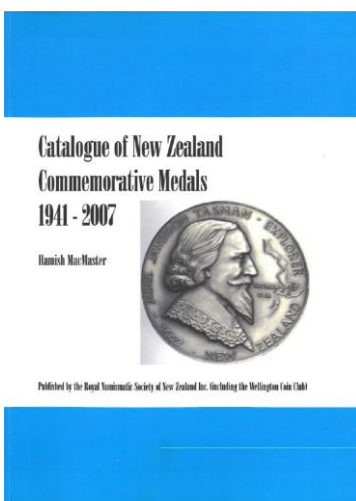

MacMaster H

New Zealand
Commemorative
Medals 1941-2007
(1st edition)

© RNSNZ 2007

ISBN
978-0-473-15585-8

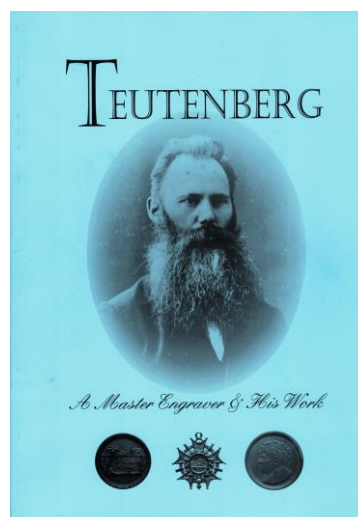

Cresswell JCM,
Duncan JB

Teutenberg, A Master
Engraver & His Work

© The authors, 2007

ISBN 0-473 07251-3

Other NZ:

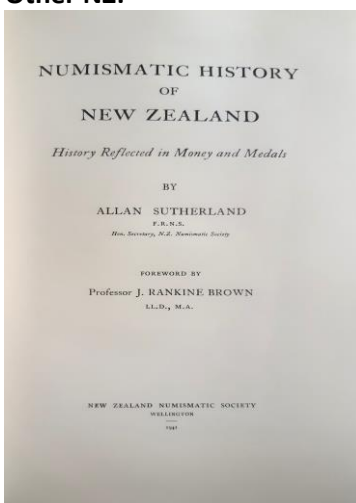

Sutherland A

Numismatic History
of New Zealand

History Reflected in
Money and Medals

© NZNS 1941



Thornton J

The John Bertrand™
New Zealand Coin &
Banknote Catalogue
2023

© John Bertrand 2023

ISBN
978-0-473-66973-7

New Zealand Commemorative Medals – 1900s

Bibliography

International:

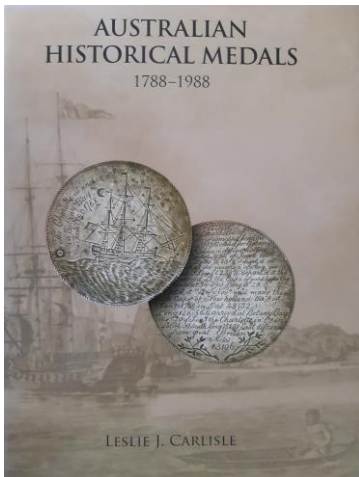

Carlisle L

Australian
Commemorative
Medals 1788-1988

© L.J. Carlisle 2008

ISBN
978-0-98040-615-3

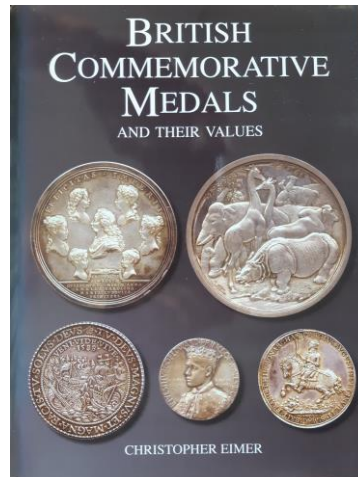

Eimer C

British
Commemorative
Medals and Their
Values

© Christopher Eimer
2010
ISBN
978-1-907427-06-0

Serials:

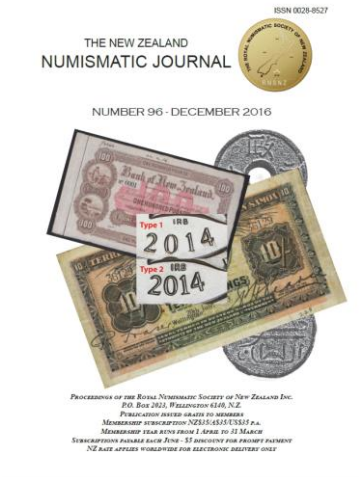

New Zealand
Numismatic Journal

© RNSNZ 1947-

ISSN 0028-8527

Royal Numismatic Society of New Zealand Inc
P O Box 2023, WELLINGTON 6140, NEW ZEALAND
E-mail: Secretary@RNSNZ.org.nz
Website: www.RNSNZ.org.nz or www.RNSNZ.com
Issue 73 Editor: David Galt

NEWSLETTER MAY 2017

COMING SOCIETY MEETINGS

RNSNZ Programme 2017		
Wednesday 26 April	St Andrew's 7.30pm	Wayne Newman "The Wellington Hoard Fraud" - Hear why the UK hoard discovery was one of the most significant recent numismatic events
Wednesday 31 May	St Andrew's 7.30pm	Members' Party with Ruckey visit - A show-and-tell on "primitive money"
Wednesday 28 June	St Andrew's Meeting Room 2 - upstairs, not our usual room. 7.30pm	Members' talks. Everyone has something to share that they know about - we look forward to your talk or 'show and tell' of up to 5 minutes.
Friday 14 - Monday 17 July	Quality Hotel, Farnell, Auckland	Decimal 50 Conference. Celebrate the 50 th anniversary of decimal currency in Auckland with the RNSA and RNSNZ's joint conference. See inside for details or find the brochure and registration form at www.RNSNZ.org.nz .
Wednesday 26 July	St Andrew's 7.30pm	Don't delay - register now. AUCK. This is scheduled after the Auckland Conference this year, to allow time for preparation of accounts
Wednesday 30 August	St Andrew's 7.30pm	RNSNZ annual auction. Cill Libby and Fleming, Sarumton
Wednesday 27 September	St Andrew's 7.30pm	Coins and banknote records will be brought from the Archives for viewing. See their updated website at www.lin heritage.co.nz

Newsletter of the
Royal Numismatic
Society of NZ Inc.

© RNSNZ 1984-
(current series)

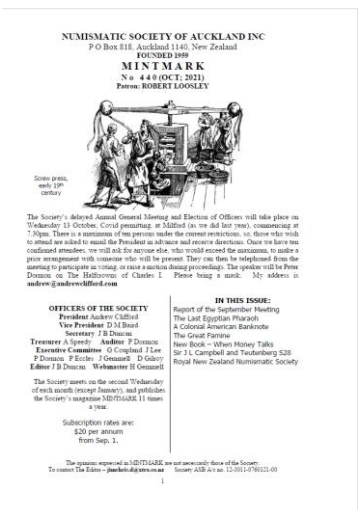

Mintmark
Newsletter of the
Numismatic Society
of Auckland Inc.

© NSA 1959-

Amendments & Updates to 1996/2000 Edition

1996/2000 Edition	This Edition	Detail
1900/3	1900/2A	Varieties grouped under a single master number
1900/4	1900/2B	
1900/6	1900/5A	
1900/7	1900/5B	
1900/10	1900/9A	
1900/14	1900/12A	
1900/16	(moved to 1890s chap.)	Double-dated 1899-1900; new 1900/16A (without loop) also moved
1900/17 (Supplement)	1900/8A	Number 1900/17 duplicated in Supplement; type belongs with 1900/8. Original 1900/17 (Godley) unchanged
1900/19	1900-01/2	Renumbered to match dating on medal
1900/20	1900-01/2A	Matching types regrouped under single number
1900/21	1900-01/2B	Note 1900/20 & 21 illustrations in 1996 edition were transposed
1900/23	1900/22A	Series grouped under a single master number
1900/24	1900/22B	
1900/25	1900/22C	
1900/26	1900/22D	
1900/27	1900/22E	
1900/29	1900/28A	Series grouped under a single master number
1900/31	1900/30A	Varieties grouped under a single master number
1900/32	1900/30B	
1900/33	1900/30C	
1900/35 (Supplement)	deleted	Number duplicated in Supplement; seems to be identical to 1900-01/2B (1900/21 as described)
1900/36	1900/35A	
1900/36 (Supplement)	1900/28.3	Number duplicated in Supplement
1900/37	1900/30D	
1900/38	1900/28B	
1901/7	1901/6A	All Ophir commems now grouped by obverse type to allow for new discoveries
1901/10	1901/9A	
1901/11	1901/9B	
1901/12	1901/9D	
1901/13	1901/9E	
1901/14	1901/9F	
1902/1	T/3	Moved to Undated chapter*
1902/3	T/4	Moved to Undated chapter*
1902/8	1902/7A	

Amendments & Updates to 2nd Edition

1996/2000 Edition	This Edition	Detail
1902/9	1902/4A	
1902/11	1902/10B	
1902/13	1902/12A	
1902/16	1902/15A	
1902/18	1902/17B	
1902/20	1902/6A	
1902/21	1902/10A	
1905/2	1905/1A	Varieties grouped under a single master number
1905/3	1905/1B	
1906/1 (Supplement)	1906/3	Number duplicated in Supplement
1906-07/6-10	Deleted	Moved to Undated chapter*; connection with 1906-07 Industrial Exhibition tenuous
1906-07/19	1906-07/18A	
1906-07/22	1906-07/20A	
1906-07/23	1906-07/20B	
1906-07/24	1906-07/20C	
1906-07/26	1906-07/25A.1	
1906-07/28	1906-07/27A.1	
1906-07/29	1906-07/27B.1	
1906-07/30	1906-07/30B	
1906-07/31	1906-07/27C	
1906-07/33	1906-07/32B.1	
1906-07/34	1906-07/32C	
1906-07/35	1906-07/32A.1	
1906-07/36	1906-07/32D	
1906-07/37	1906-07/30A	
1906-07/42	1906-07/41A	
1906-07/46	1906-07/45A	
1906-07/52	1906-07/39A	
1906-07/54	1906-07/27D	
1906-07/55	1906-07/30	
1907/3	1907/2B	Varieties grouped under a single master number
1907/4	1907/1B	Varieties grouped under a single master number
1907/5	1907/2A	
1909/2	Deleted	Refers to church in St Andrew's, Scotland
F/1	1905/4D	Foudroyant issues grouped with HMS Victory

Previous catalogue numbers (if changed) are given in brackets under the current catalogue number. “(-)” below the current catalogue number indicates a new entry, not logged in the 1996 edition or the 2000 Supplement.

* Chapter dedicated to undated items still pending as at September 2023

Commemorative Medals – Issues of the 1900s

SOUTH AFRICAN WAR 1899-1902

The war commenced in the 2nd week of October, 1899, when the Transvaal and Orange Free State Forces attacked British troops in the Cape Colony. The New Zealand Prime Minister, Richard Seddon, offered to the British Prime Minister, Joseph Chamberlain, 250 mounted rifles. Whilst being declined when it was originally made on 3 October, it was accepted on the commencement of hostilities. The first two contingents numbered between 200 and 220 volunteers from the trained Militia. These departed from New Zealand between 21 October 1899 and 20 January 1900. The Third and Fourth contingents had no previous military training but were skilled marksmen and horsemen. These contingents were known as Rough Riders. Commencing with the Fifth contingent, the British Government paid all expenses of the New Zealand troops. The Fifth, Sixth and Seventh contingents numbered between 500 and 600 men, while the Eighth to the final contingent, the Tenth, which left on 19 April 1902, numbered just over 1,000 men in each contingent. The total troops which departed New Zealand for the Boer War numbered 6,495, of whom 228 lost their lives and 166 were wounded during the 30 months of fighting.







1900/1

Diameter: 21 mm, loop suspension (may be broken off)
Metal: Silver
Rarity: R4



Obverse: Veiled head of Queen Victoria to L in inverted horseshoe; 1900 between leaf decorations below. Inscr around above SECOND N.Z. CONTINGENT and * TRANSVAAL * below
Reverse: NZ flag; two banners at L reading RANFURLY / GOVERNOR in front of fern leaf; JANUARY 1900 centred below. Inscr around above NEW ZEALAND and around below WELLINGTON

Commemorative Medals – 1900s

	<p>1900/1A (-)</p>	
	<p>Diameter: 21 mm Metal: Silver, White Metal (pierced) Rarity: R6</p>	
	<p>[1900/1A.1]</p>	
<p>Obverse: Māori warrior (head and shoulders) facing $\frac{3}{4}$ L with taiaha, between crossed fern leaves Reverse: NZ flag in centre; SUCCESS above; TO at R (and trace of "N.Z." below?); below flag NEW ZEALAND / CONTINGENT / JAN 1900 Versions: 1900/1A.1 Silver 1900/1A.2 White Metal</p>		
	<p>[1900/1A.2]</p>	



1900/2

Diameter: 24 mm, loop suspension or pierced

Metal: Gilt, Copper, White Metal, Silver

Rarity: R6 (all)

Maker: Moller & Young

[1900/2.1.1]

Obverse: TO / COMMEMORATE / THE DEPARTURE / OF / NZ TROOPS / FROM / LYTTTELTON / FEB 1900 in open wreath

Reverse: Veiled head of Queen Victoria to L; inscr around above FOR QUEEN & COUNTRY. Crown to left leg of N. In small letters below M & Y. Beaded circle inside rim

Versions:

- 1900/2.1.1 Gilt, loop
- 1900/2.1.2 Gilt, pierced
- 1900/2.2 Copper, loop
- 1900/2.3 White Metal, loop
- 1900/2.4 Silver, loop





[1900/2.1.2]





[1900/2.2]



Commemorative Medals – 1900s



Commemorative Medals – 1900s



1900/2A
(1900/3)

Diameter: 23.5 mm, pierced
Metal: Gilt, Bronze
Rarity: R5 (both)
Maker: Moller & Young



[1900/2A.1]

Obverse: Like 1900/2
Reverse: Like 1900/2 but rim beads irregular and touching
Versions: 1900/2A.1 Gilt
 1900/2A.2 Bronze

[illustration unavailable]

[1900/2A.2]

[illustration unavailable]



1900/2B
(1900/4)

Diameter: 23.5 mm, pierced
Metal: Gilt
Rarity: R6
Maker: Moller & Young



Obverse: Like 1900/2A but N.Z. with stops, and incorrect spelling LYTTLETON
Reverse: Like 1900/2 but larger rim beads, no M & Y, crown to right leg of N

Note: Nos. 1900/3 and 4 have been retired

1900/5

[illustration unavailable]

Diameter: 24 mm, loop
suspension,
pierced
Metal: Silver,
White metal
Rarity: R6 (both)
Maker: Moller & Young

[illustration unavailable]

[1900/5.1]

Obverse: TO / COMMEMORATE / THE / DEPARTURE / -> OF <- / N.Z. TROOPS / -> FROM <- / OTAGO / MAR 1900 in open wreath (Note: arrows may be faint; COMMEMORATE is curved, not straight)

Reverse: Like 1900/2

Versions: 1900/5.1 Silver, loop
1900/5.2 White metal, pierced



[1900/5.2]



1900/5A
(1900/6)



Diameter: 24 mm, pierced and unpierced
 Metal: Gilt, Lead, Copper, pierced and unpierced
 Rarity: R6 (all)
 Maker: Moller & Young



[1900/5A.1]

Obverse: Like 1900/5

Reverse: Like 1900/2A

Versions: 1900/5A.1 Gilt, pierced

1900/5A.2 Lead

1900/5A.3 Copper, loop suspension (broken in illustrated example)

[illustration unavailable]

[1900/5A.2]

[illustration unavailable]



[1900/5A.3]



Commemorative Medals – 1900s



1900/5B
(1900/7)

Diameter: 24 mm, pierced
Metal: Gilt, White metal
Rarity: R6 (both)
Maker: Moller & Young



[1900/5B.1]

Obverse: Like 1900/5

Reverse: Like 1900/2 but crown point between EE, no beads, small M under truncation. Full stop after COUNTRY.

Versions: 1900/5B.1 Gilt
1900/5B.2 White metal

[illustration unavailable]

[1900/5B.2]

[illustration unavailable]

Note: Nos. 1900/6 and 7 have been retired

1900/8



Diameter: 24 mm, pierced
Metal: Gilt, Copper,
White Metal
Rarity: R5, R5, R7?
Maker: Moller & Young



[1900/8.1]

Obverse: TO / COMMEMORATE / THE / DEPARTURE OF / N.Z. ROUGH * / * RIDERS / FROM OTAGO / MAR 1900 in wreath. Note 9 of date raised, possibly struck over a 6 or an inverted 9.

Reverse: Like 1900/5B

Versions: 1900/8.1 Gilt
1900/8.2 Copper



[1900/8.2]





1900/8A

(1900/17 in Supplement)

Diameter: 24 mm
Metal: Silver
Rarity: R6
Maker: Moller & Young

[1900/8A.1]

Obverse: Like 1900/8
Reverse: Like 1900/2
Versions: 1900/8A.1 Silver, unpierced
1900/8A.2 White metal, pierced

[1900/8A.2]

Commemorative Medals – 1900s

	1900/9	
	Diameter: 24 mm, pierced & unpierced Metal: Gilt, Copper Rarity: R7 (both) Maker: Moller & Young	
	[1900/9.1]	
<p>Obverse: Crossed flags in dotted circle. Inscr around above SUCCESS TO 3RD CONTINGENT and around below ..1900.. Note: Staff left (NZ) flag to T, staff of right (UK) flag to C</p> <p>Reverse: Like 1900/2A</p> <p>Note: Uncertain at this stage which metal versions exist unpierced</p> <p>Versions: 1900/9.1 Gilt 1900/9.2 Copper</p>		
	[1900/9.2]	

Commemorative Medals – 1900s

	<p>1900/9A (1900/10)</p>	
<p>Diameter: 23.5 mm, loop suspension or pierced Metal: Silver, Bronze, Aluminium Rarity: R7 (all) Maker: Moller & Young</p>		
<p>[1900/9A.1]</p>		
<p>Obverse: Like 1900/9 but staff of New Zealand flag to 3rd, and staff of Union Jack to O; period after CONTINGENT, and date between single dots</p>		
<p>Reverse: Like 1900/2B but M & Y below truncation</p>		
<p>Versions: 1900/9A.1 Silver, loop 1900/9A.2 Bronze, pierced 1900/9A.3 Aluminium</p>		
	<p>[1900/9A.2]</p>	
<p>[illustration unavailable]</p>	<p>[1900/9A.3]</p>	<p>[illustration unavailable]</p>

Note: No. 1900/10 has been retired

Commemorative Medals – 1900s

1900/11



Diameter: 24 mm, pierced
Metal: Gilt
Rarity: R7
Maker: Moller & Young



Obverse: Like 1900/9 but 4TH replaces 3RD in legend
Reverse: Like 1900/5B

1900/11A

(-)



Diameter: 24 mm, loop suspension
Metal: Silver
Rarity: R7
Maker: Moller & Young



Obverse: Like 1900/11
Reverse: Like 1900/2



1900/12

Diameter: 21 mm, loop suspension
 Metal: Silver, Gilt, Gold (18ct)
 Rarity: R4, R4, R7



[1900/12.1]

Obverse: Inscr in centre THE / DEPARTURE / OF THE / N.Z. ROUGH RIDERS / TO THE / TRANSVAAL; around above TO COMMEMORATE and around below 1900. Note: T of THE below mid-point of GH

Reverse: Mounted soldier holding rifle, riding to L. Inscr. N.Z. ROUGH RIDERS around above; banner reading KIA TOA AKE AKE! [Be brave for ever and ever!] below; crossed ferns in exergue. Note: Gap between horse's mouth and hilltop wider than gap between horse's head and rifle butt

Versions: 1900/12.1 Silver
 1900/12.2 Gilt
 1900/12.3 Gold (18 ct)



[1900/12.2]



[1900/12.3]





1900/12A

(1900/14)

Diameter: 21 mm, loop suspension (may be broken off)
Metal: Silver, Copper
Rarity: R6, R6



[1900/12A.1]

Obverse: Like 1900/12

Reverse: Like 1900/12 but horse has cruder shape, no ! after AKE. Gap between horse's mouth and hilltop narrower than gap between horse's head and rifle butt

Versions: 1900/12A.1 Silver (loop broken off in illustration above)
1900/12A.2 Copper (loop likely broken off in illustration below)



[1900/12A.2]





Commemorative Medals – 1900s

	1900/13 Diameter: 21 mm, loop suspension Metal: Silver, Gilt Rarity: R4, R4	
	[1900/13.1]	
Obverse: Like 1900/12 but T of THE under H of ROUGH Reverse: Like 1900/12 Versions: 1900/13.1 Silver 1900/13.2 Gilt		
		
	[1900/13.2]	

Note: No. 1900/14 has been retired

	<p>1900/15</p> <p>Diameter: 25.5 mm, loop suspension</p> <p>Metal: Silver, Gilt</p> <p>Rarity: R7</p> <p>[1900/15.1]</p>	
<p>Obverse: Inscr in centre THE / DEPARTURE / OF THE / OTAGO & SOUTHLAND [text curved] / CONTINGENT / TO THE / TRANSVAAL; around above TO COMMEMORATE and around below 1900</p> <p>Reverse: Like 1900/12A</p> <p>Versions: 1900/15.1 Silver 1900/15.2 Gilt</p>		
<p>[illustration unavailable]</p>	<p>[1900/15.2]</p>	<p>[illustration unavailable]</p>

	<p>1900/15A (-)</p> <p>Diameter: 25.5 mm</p> <p>Metal: Copper</p> <p>Rarity: R7</p>	
<p>Obverse: Like 1900/15</p> <p>Reverse: Like 1900/12</p>		

[No. 1900/16 and new variety without loop moved to 1890s chapter (dated 1899-1900)]

CANTERBURY JUBILEE EXHIBITION 1900

(see also M1900-01/2)

Organised by the Canterbury Industrial Association, the exhibition was held in Canterbury Hall and annex. A Government subsidy of £1,000 was provided and prominent persons attended the opening, these included Governor Ranfurly, Prime Minister Richard (Dick) Seddon and Sir Joseph Ward. Attendance was 300,000 and a profit of £3,000 resulted for the Association. Goods displayed at the exhibition were of New Zealand origin or manufacture.



1900/17

Diameter: 22.5 mm, pierced
 Metal: Silver, Gilt,
 Copper, Nickel
 plated
 Rarity: R4 (all)



[1900/17.1]

Obverse: Exhibition building in centre, CANTERBURY below. Inscr around above N.Z. EXHIBITION and around below JUBILEE 1900

Reverse: In centre circle John Robert Godley (1814-1861), facing $\frac{3}{4}$ L. JOHN ROBERT GODLEY around. In outer circle around above CANTERBURY JUBILEE 1900 and around below . PROVINCE FOUNDED 1850 BY .

Versions: 1900/17.1 Silver
 1900/17.2.1 Gilt, pierced
 1900/17.2.2 Gilt, unpierced
 1900/17.3 Copper
 1900/17.4 Nickel plated



[1900/17.2.1]



[1900/17.2.2]



Commemorative Medals – 1900s



[1900/17.3]

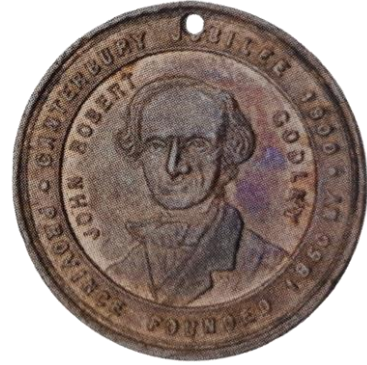

[illustration unavailable]

[1900/17.4]

[illustration unavailable]

1900/18



Diameter: 22 mm, pierced & unpierced
 Metal: Silver, Copper, White metal
 Rarity: R5 (all)
 Designed and struck by Anton Teutenberg, Auckland



[1900/18.1]

Obverse: Exhibition building in centre; EXHIBITION above, 1900 below. In two rows around above CANTERBURY JUBILEE / INDUSTRIAL (Maker's initials A.T. below building at L)

Reverse: Wreath in centre with space for engraving. 1900 below. Inscr around above STRUCK AT THE JUBILEE EXHIBITION MINT

Versions: 1900/18.1 Silver
 1900/18.2 Copper
 1900/18.3 White metal



[1900/18.2]



[1900/18.3]



1900/22



Diameter: 19 mm, loop suspension
 Metal: Bronze
 Rarity: R6
 Maker: Lauer



Obverse: Exhibition building in centre, EXHIBITION above, 1900 below. Inscr around above CANTERBURY JUBILEE INDUSTRIAL (Note maker's name LAUER on base of building at R.)
 Reverse: In centre beaded circle Col. Robert Baden-Powell (1857-1941), ¾ facing L. Inscr around left COLONEL R.S.P. [sic] and around right BADEN-POWELL. In outer circle inscr around above STRUCK AT CANTERBURY JUBILEE INDUSTRIAL EXHIBITION and below . 1900 .

1900/22A
 (1900/23)



Diameter: 19 mm, loop suspension
 Metal: Bronze
 Rarity: R6
 Maker: Lauer



Obverse: Like 1900/22
 Reverse: In centre beaded circle General Sir Redvers Buller (1839-1908), ½ facing L. Inscr around left GENERAL and around right SIR R. BULLER. In outer circle inscr around above STRUCK AT CANTERBURY JUBILEE INDUSTRIAL EXHIBITION and below . 1900 .

Note: Nos. 1900/19-21 have been retired. See under 1900-01 issues.

1900/22B

(1900/24)

[illustration unavailable]

Diameter: 19 mm, loop
suspension
Metal: Gilt, Bronze
Rarity: R5, R5
Maker: Lauer

[illustration unavailable]

[1900/22B.1]

Obverse: Like 1900/22

Reverse: In centre beaded circle Lieutenant-General John Denton Pinkstone French (1852-1925), $\frac{1}{4}$ facing L. Inscr around left LIEUTENANT-GENERAL and around right J.D.P. FRENCH. In outer circle inscr around above STRUCK AT CANTERBURY JUBILEE INDUSTRIAL EXHIBITION and below * 1900 * (Note stars replace dots around date on 1900/22B, 22C and 22E)

Versions: 1900/22B.1 Gilt
1900/22B.2 Bronze



[1900/22B.2]



1900/22C

(1900/25)



Diameter: 19 mm, loop
suspension
Metal: Bronze
Rarity: R6
Maker: Lauer



Obverse: Like 1900/22

Reverse: In centre beaded circle Major-General Lord Horatio Herbert Kitchener (1850-1916), $\frac{3}{4}$ facing R. Inscr around left MAJOR-GENERAL and around right LORD KITCHENER. In outer circle inscr around above STRUCK AT CANTERBURY JUBILEE INDUSTRIAL EXHIBITION and below * 1900 *



1900/22D
(1900/26)



[1900/22D.1]

Obverse: Like 1900/22
 Reverse: In centre beaded circle Major-General Hector Archibald MacDonal (1853-1903), ½ facing R. Inscr around above MAJOR GENERAL HECTOR MACDONALD. In outer circle inscr around above STRUCK AT CANTERBURY JUBILEE INDUSTRIAL EXHIBITION and below . 1900 .

Versions: 1900/22D.1 Gilt
 1900/22D.2 Bronze



[1900/22D.2]





1900/22E
(1900/27)



Obverse: Like 1900/22
 Reverse: In centre beaded circle Field-Marshal Frederick Sleigh Roberts, 1st Earl Roberts (1832-1914), ¾ facing L. Inscr around left FIELD-MARSHAL and around right LORD ROBERTS. In outer circle inscr around STRUCK AT CANTERBURY JUBILEE INDUSTRIAL EXHIBITION * 1900 *

Note: Nos. 1900/23-27 have been retired



1900/28
(1900/28; 1900/36 in Supplement)

Diameter: See below; loop suspension,
Maltese cross
Metal: Silver, Copper,
Gold
Rarity: R6, R6, R6



[1900/28.1]

Obverse: In centre, arms of Canterbury; 19 to L, 00 to R; CANTERBURY above, JUBILEE below; INDUSTRIAL at L, EXHIBITION at R (Note: 19 of date to DU, 00 of date to TI)

Reverse: Centre blank for engraving. WORKERS' at top, EXHIBITS at base

Versions: 1900/28.1 Silver (27.5 mm)
1900/28.2 Copper (22.5 mm)
1900/28.3 Gold (22 mm) (was 1900/36 in Supplement)

[illustration unavailable]

[1900/28.2]

[illustration unavailable]



[1900/28.3]
Note: 19 of date to D,
00 of date to IO



Note: No. 1900/29 has been retired

	<p>1900/28A (1900/29)</p>	
<p>Diameter: See below; Maltese cross Metal: Silver, Gold Rarity: R5, R6</p>		
<p>[1900/28A.1]</p>		
<p>Obverse: Like 1900/28 (Note: 19 of date do DU, 00 of date to TI) Reverse: Centre blank for engraving. HOME at top, INDUSTRIES at base Versions: 1900/28A.1 Silver (27.5 mm) 1900/28A.2 Gold (22 mm)</p>		
	<p>[1900/28A.2] Note: 19 of date to D, 00 of date to IO</p>	

	<p>1900/28B (Supplement: 1900/38)</p>	
<p>Diameter: 33 x 33 mm, Maltese cross shaped Metal: Gold (9 ct acc. to Morel; tested 18 ct acc. to Noble) Rarity: R6</p>		
<p>Obverse: Like 1900/28 Reverse: A SOUVENIR [text convex] / OF THE / C.J.I.E. / FROM / THE EXECUTIVE TO / [name] / CHAIRMAN / [committee name] / COMMITTEE Note: This medal was used as a presentation medal and given to Chairmen of various committees of C.J.I.E. (Canterbury Jubilee Industrial Exhibition) Names noted: C H Elliott, Chairman Exhibits Committee R.B. Wood, Chairman Building Committee</p>		

JUBILEE OF CANTERBURY 1900

1900/30



Diameter: 23.5 mm, pierced
 Metal: Copper
 Rarity: R3
 Maker: Moller & Young,
 Christchurch



Obverse: Inscr in wreath TO / COMMEMORATE / -> THE <- / JUBILEE / -> OF <- / CANTERBURY / N.Z. In small letters below wreath M & Y, Ch.
 Reverse: Arms of Christchurch. 1850 above, 1900 below. Dates break circle of rim beads; bead arrangement irregular. Note: smokestack of train below 8

1900/30A
 (1900/31)



Diameter: 23.5 mm, pierced
 Metal: Copper
 Rarity: R5
 Maker: Moller & Young,
 Christchurch





Obverse: Like 1900/30
 Reverse: Like 1900/30 but shield and beads differ. Note: smokestack of train points between 1 and 8

Commemorative Medals – 1900s

	1900/30B (1900/32)	
	<p>Diameter: 23.5 mm, pierced Metal: Copper Rarity: R5 Maker: Moller & Young, Christchurch</p>	
<p>Obverse: Like 1900/30 Reverse: Like 1900/30 but dates inside full circle of rim beads; 3rd minor variety of shield</p>		

	1900/30C (1900/33)	
	<p>Diameter: 23.5 mm, pierced Metal: Copper Rarity: R6 Maker: Moller & Young, Christchurch</p>	
<p>Obverse: Like 1900/30 Reverse: Like 1900/30 but no rim beads; 1900 between stars; 4th minor variety of shield</p>		

	1900/30D (1900/37)	
	<p>Diameter: 23.5 mm, pierced Metal: Copper Rarity: R6 Maker: Moller & Young, Christchurch</p>	
<p>Obverse: Like 1900/30 Reverse: Shield like 1900/30C but dates break circle of rim beads, additional +-like symbol above dots to L and R of date 1900</p>		

LABOUR DAY DEMONSTRATION 1900

Labour Day became a National Holiday in 1900 in New Zealand after the passing of the Labour Day Act in 1899.

1900/34

[Illustration unavailable]	Diameter: 31 mm	[Illustration unavailable]
	Metal: Lead (cast)	
	Rarity: R7	

Obverse: LABOUR DAY DEMONSTRATION 1900
Reverse: VICTORIA. DEI GRA. REGINA. FID. DEF. IND. IMP
Note: British penny type 1895-1901

Note: Nos. 1900/31-33 have been retired

END OF TRANSVAAL WAR 1900

A number of medallic issues indicate a belief or expectation that the War would end in 1900, though this proved to be premature. M1900/35 and 35A below are examples, as was an early version of the Queen's South Africa Medal (subsequently re-released with the dates 1899-1900 effaced). The undated medals previously listed as 1902/1 and 1902/3, now moved to the Undated chapter, may, on closer analysis, also fit into this category.

1900/35



Diameter: 27 mm
 Metal: Copper, Bronze
 Rarity: R6
 Maker: J. Swan & Co.



[1900/35.1]

Obverse: Cartoon-like effigy of Queen Victoria similar to Jubilee Head to L in oval between NZ and UK flags. Two kiwis above. Inscr around in two concentric circles IN COMMEMORATION . OF . TERMINATION . OF . THE . WAR . IN . SOUTH . AFRICA . 1899 - 1900 / IN . WHICH . 1788 . MEN . FROM . NEW ZEALAND . TOOK . PART

Reverse: In beaded centre circle mounted soldier to R with hills behind. SWAN in small letters below L. Inscr in outer circle around PRESENTED . TO . CHILDREN . ATTENDING . N.Z . STATE SCHOOLS

Versions: 1900/35.1 Copper, SWAN on rev
 1900/35.2 Bronze, thin flan, SWAN on rev



[1900/35.2]



Commemorative Medals – 1900s

	<p>1900/35A (1900/36)</p>	
<p>Diameter: 27 mm Metal: Gilt, Copper Rarity: R7, R6 Maker: Bock</p>		
<p>[1900/35A.1]</p>		
<p>Obverse: Like 1900/35 but smaller, neater effigy of Queen Victoria; no stops between words, rosette dividing legend at base. Initials WRB (William Rose Bock) below LH flag Reverse: Like 1900/35 but larger letters, no stops between words, rosette divides legend at base. Note: no "SWAN" (cf. 1900/35.1 and 35.2) Versions: 1900/35A.1 Gilt 1900/35A.2 Copper</p>		
	<p>[1900/35A.2]</p>	

Note: Nos. 1900/36-38 have been retired.

GRAND LODGE OF NEW ZEALAND 10 YEARS 1900



1900/39
(-)

Diameter: 36 mm
Metal: Silver, Copper
Rarity: R7, R6
Maker: Hamburg State Mint



(1900/39.1)

Obverse: A shield of Arms, divided quarterly by a plain cross: first gules three lions passant; second argent seme of five stars; third azure an Irish harp; fourth or a lion rampant. For crest, the compasses and sector, a plumb line suspended from the joint. The whole within a chaplet of laurel. Around, GRAND LODGE OF NEW ZEALAND/
ANTIENT FREE AND ACCEPTED MASONS

Reverse: In an oval shield, the Arms of New Zealand, the motto ADVANCE NEW ZEALAND around the upper edge, and below, on a scroll among flowers, AUDI VIDE TACE ["Hear, see, remain silent"]. In outer circle, IN COMMEMORATION OF TEN YEARS SUCCESSFUL MASONIC WORK 1890—1900

Designer (?): Carl Cornelius Wiebe (1850-1910), Numismatist, Past Grand Master of the Grand Lodge of New Zealand 1900, Grand Master, and Past Grand Master of the Grand Lodge of Hamburg, Germany

Note: These are medallic copies of a gold jewel to be worn by the Grand Master, the original of which is held by the museum of the Grand Lodge of New Zealand. Medal descriptions from

<https://catalogue.wmlmt.org.uk/wiki/1938/55.1: Bronze Medal: 10th Anniversary of the Grand Lodge. New Zealand 1900>

Biographical details courtesy of Georg Kaul

Versions: 1900/39.1 Silver
1900/39.2 Copper



(1900/39.2]

Note additional text in reverse field below scroll: PRESENTED BY BRO.: C.C. WIEBE HAMBURG. P.G.M. NEW ZEALAND.



TRANSVAAL WAR 1900



1900/40
(-)

Diameter: 22 mm
Metal: Silver
Rarity: R7



Obverse: Engraved TRANSVAAL / WAR / 1900

Reverse: Engraved PRESENTED / TO / ROY PIRANI, / BY / J.R. Montague / FOR / EFFICIENT / DRILL

Note: See former 1902/3 (now moved to Undated section) for a struck medal by the firm of J.R. Montague (1856-1901)

GREYMOUTH WESTLAND CELEBRATIONS 1900-01

1900-01/1

(-)

[illustration unavailable]

Diameter: 30.5 mm, pierced;
loop suspension

Metal: Silver, Gilt,
Copper

Rarity: R4, R2, R2

[illustration unavailable]

[1900-01/1.1]

Obverse: Veiled head of Queen Victoria to L in dotted circle. In outer circle inscr around above CENTENNIAL CELEBRATION and below 1900 - 1901

Reverse: Anchor in rope circle. In inner circle around inscr above COAL . TIMBER and around below * GOLD *; in outer circle around above GREYMOUTH WESTLAND and around below – NEW ZEALAND –

Versions: 1900-01/1.1 Silver
1900-01/1.2 Gilt
1900-01/1.3 Copper



[1900-01/1.2]



[1900-01/1.3]



CANTERBURY JUBILEE INDUSTRIAL EXHIBITION 1900-01

(see also M1900/17, 18, 22, 28)

1900-01/2

(1900/19)



Diameter: 19 mm, loop suspension; versions with no loop suspension also reported

Metal: Gilt, Bronze, Aluminium

Rarity: R3, R3, R4



[1900-01/2.1]

Obverse: Exhibition building. Inscr around above CANTERBURY JUBILEE. In exergue INDUSTRIAL / EXHIBITION / 1900 – 1901

Reverse: Small oak wreath above (8 clusters), ends of centre ribbons point in opposing directions. Field blank for engraving. Inscr CH . CH . curved at base

Versions: 1900-01/2.1 Gilt
1900-01/2.2 Bronze
1900-01/2.3 Aluminium



[1900-01/2.2]



[1900-01/2.3]



1900-01/2A

(1900/20)

Diameter: 17 mm, loop
suspension

[illustration unavailable]

Metal: Copper,
Aluminium

[illustration unavailable]

Rarity: R3, R3

[1900-01/2A.1]

Obverse: Like 1900-01/2 but left tower point touches A

Reverse: Like 1900-01/2 but ten clusters of leaves; ribbon ends point toward each other

Versions: 1900-01/2A.1 Copper
1900-01/2A.2 Aluminium



[1900-01/2A.2]



1900-01/2B

(1900/21)



Diameter: 16.5 mm, loop suspension; *uncertain if examples with no loop are original or broken*

Metal: Silvered copper, Aluminium

Rarity: R6, R6



[1900-01/2B.1]

Obverse: Like 1900-01/2 but point of left tower reaches N, no window frames in towers

Reverse: Like 1900-01/2 but ribbon ends apart and point to the left (8 clusters)

Versions: 1900-01/2B.1 Silvered copper

1900-01/2B.2 Aluminium



[1900-01/2B.2]



LABOUR DAY DEMONSTRATIONS 1901

1901/1

[illustration unavailable] Diameter: 31 mm
Metal: Copper, Lead
Rarity: R7, R6 [illustration unavailable]

[1901/1.1]

Obverse: 1901 in dotted circle, solid circle around. Inscr around above * LABOUR DAY * and around below DEMONSTRATION

Reverse: Blank centre with dotted circle. Inscr around above *** ONE FOR ALL *** and around below ALL FOR EACH, in dotted outer circle

Versions: 1901/1.1 Copper
1901/1.2 Lead



[1901/1.2]



DEATH OF QUEEN VICTORIA 1901

1901/2



Diameter: 25.5 mm, loop
suspension
Metal: Gold 15 ct
Rarity: R7

[illustration unavailable]

Obverse: Crowned veiled head of Queen Victoria facing $\frac{1}{2}$ L, dividing legend around above IN MEMORIAM and 1819 – 1901

Reverse: Blank

Note: Issued by J. [G.?] Coates, Watchmaker and Jeweller, Colombo Street, Christchurch

DUKE AND DUCHESS OF CORNWALL AND YORK VISIT 1901

1901/3



Diameter: 25.5 mm, pierced
Metal: White metal
Rarity: R4



Obverse: IN COMMEMORATION (curved) / OF / THE VISIT TO / NEW ZEALAND / OF THE / DUKE & DUCHESS / OF CORNWALL & YORK, 1901 (last two lines curved)

Reverse: In centre circle conjoined busts of George (1865-1936) and Mary (1867-1953), Duke and Duchess of Cornwall and York, to R. In outer circle inscr around above THEIR . R. H. THE DUKE & DUCHESS OF YORK, three stars below.



1901/4

Diameter: 34 x 26 mm,
loop suspension,
lozenge shaped
Metal: Gilt, Aluminium,
White metal
Rarity: All R6



[1901/4.1]

Obverse: In inner lozenge-shaped frame, shield with ER monogram, UK and NZ flags behind. Inscr in outer lozenge TO CELEBRATE T.R.H. THE DUKE & DUCHESS OF YORK'S VISIT.

Reverse: In inner lozenge, conjoined busts of Duke & Duchess to L; JUNE / 1901 below. Inscr in outer lozenge NEW ZEALAND WELCOMES HER ROYAL VISITORS. Note: angles of inner lozenge open

Versions: 1901/4.1 Gilt
1901/4.2 Aluminium
1901/4.3 White metal

[illustration unavailable]

[1901/4.2]

[illustration unavailable]



[1901/4.3]



1901/5

[illustration unavailable]

Diameter: 25 x 20.5 mm,
loop suspension,
oval shaped

[illustration unavailable]

Metal: Gilt, Aluminium

Rarity: Both R6

[1901/5.1]

Obverse: T. R. H. / DUKE & DUCHESS (curved) / OF / CORNWALL & YORK / -- / BRITISH COLONIES
(curved) / 1901 / H.M.S. OPHIR (curved)

Reverse: Crowned anchor with superimposed rose and garter, inscr. HONI SOIT QUI MAL Y PENSE

Versions: 1901/5.1 Gilt
1901/5.2 Aluminium



[1901/5.2]



**Duke & Duchess of Cornwall/HMS Ophir visit, M1901/6-1901/9
(previously M1901/6-1901/14)**

Note: for the following series (1901/6 – 1901/9 and sub-types), please refer to the overview of obverse and reverse types below to help with identification. This series is definitely a “work in progress” and it is likely that other subtypes remain to be discovered.

There are at least eleven known types in this medal series, which has been renumbered for the new edition of the catalogue. They have been broadly divided by key obverse (ship side) features, as follows:

- Flat base to water, smoke from smokestacks: **1901/6**
- Curved base to water, smoke from smokestacks: **1901/8**
- Curved base to water, no smoke: **1901/9**

Reverse (portrait side) varieties in each case have been defined as sub-types within these three groups. Previous catalogue numbers 1901/7 and 1901/10-14 have been retired.

Metal types: Because it is possible that new metal varieties will be discovered, a standardised numbering system for the various metals has been adopted for this group of medals only, viz.:

- xxx.1 Silver
- xxx.2 Silvered
- xxx.3 Gilt
- xxx.4 Copper
- xxx.5 Chromed

These will be applied consistently. Any gaps will indicate that the composition in question is not (yet) known, and that space has been left for it accordingly.

1901/6 – 1901/9G

**OVERVIEW OF OBTVERSE AND REVERSE TYPES:
Distinguishing features and basic descriptions**



Obv. 1

Flat base to water, no scroll around date, smoke from stacks, dot after N.Z. in surrounding legends
Inscr around H.M.S. OPHIR IN WHICH THEIR ROYAL HIGHNESSES CAME TO N.Z.



Obv. 2

Curved base to water, date JUNE . 1901 in scroll, smoke, rosette after N.Z. W.R.B. below water at L. Water: left point to N, right point between E and S.
Below scroll G.T. WHITE at left; WEEL^N (sic) below R
Inscr around H.M.S. OPHIR, IN WHICH THEIR ROYAL HIGHNESSES CAME TO N.Z.



Obv. 3

Curved base to water, date . JUNE . 1901 . in scroll, no smoke, rosette after N.Z. No W.R.B. Water: left point to I, right point below S.
Below scroll G.T. WHITE at left; correct spelling WELL^N below scroll at R
Inscr around H.M.S. OPHIR, IN WHICH THEIR ROYAL HIGHNESSES CAME TO N.Z.



Obv. 4

Curved base to water, date . JUNE . 1901 . in scroll in scroll, no smoke, rosette after N.Z. No W.R.B. Water: left point to comma, right point between E and S.
Below scroll G.T. WHITE at left; WELL^N below scroll at R
Inscr around H.M.S. OPHIR, IN WHICH THEIR ROYAL HIGHNESSES CAME TO N.Z.



Obv. 5

Curved base to water, date JUNE 1901 in scroll, no smoke, rosette after N.Z. No W.R.B. No comma. Water: left point to R, right point between E and S.
Below scroll G.T. WHITE at left; WELL^N below scroll at R
Inscr around H.M.S. OPHIR IN WHICH THEIR ROYAL HIGHNESSES CAME TO N.Z.



Obv. 6

Curved base to water, date JUNE 1901 in scroll, no smoke, rosette after N.Z. No W.R.B. No comma. Water: left point below I, right point to E
Below scroll G.T. WHITE at left; WELL^N below scroll at R
Inscr around H.M.S. OPHIR IN WHICH THEIR ROYAL HIGHNESSES CAME TO N.Z.



Rev. A

Dot after N.Z. Duke: tall head, medium beard. Duke's shoulder to A, small & in legend.

Inscr around CHILDREN'S (no apostrophe) SOUVENIR, VISIT DUKE & DUCHESS OF CORNWALL TO N.Z.



Rev. B

Dot after N.Z. Duke: round head, short beard. Duchess has less pointy nose. Duke's shoulder to L, small &.

Inscr around CHILDREN'S SOUVENIR, VISIT DUKE & DUCHESS OF CORNWALL TO N.Z.



Rev. C

Rosette after N.Z. Duke: tall head, long beard. Duke's shoulder to W, small &. W.R.B. below Duke's bust

Inscr around CHILDREN'S SOUVENIR, VISIT DUKE & DUCHESS OF CORNWALL TO N.Z.



Rev. D

Dot with 4 points* after N.Z. Duke: tall head, medium beard. Duke's shoulder to A, small &.

Inscr around CHILDREN'S SOUVENIR, VISIT DUKE & DUCHESS OF CORNWALL TO N.Z.



Rev. E

Cruder busts. Duke: tall head, medium beard, long, thin ear. Duchess has receding chin. Duke's shoulder to L, O of TO almost touches N, large &.

Inscr around CHILDREN'S SOUVENIR, VISIT DUKE & DUCHESS OF CORNWALL TO N.Z.



Rev. F

Dot with 4 points* after N.Z. Duke: tall head, medium beard, normal ear. Duke's shoulder between A and L, large &.

Inscr around CHILDREN'S SOUVENIR, VISIT DUKE & DUCHESS OF CORNWALL TO N.Z.

* Points may be very faint or almost invisible; dot may look like a triangle pointing down

Commemorative Medals – 1900s

	<p>1901/6</p>	
<p>Obverse: Obverse 1 Reverse: Reverse A Versions: 1901/6.1 Silver 1901/6.4 Copper</p>	<p>Diameter: 27 mm Metal: Silver (loop suspension), Copper (pierced) Rarity: Both R3</p>	<p>[1901/6.1]</p>
	<p>[1901/6.4]</p>	

Commemorative Medals – 1900s

	<p>1901/6A (1901/7)</p>	
	<p>Diameter: 27 mm, pierced and unpierced Metal: Silver Rarity: R5</p>	
	<p>[1901/6A.1.1]</p>	
<p>Obverse: Obverse 1 Reverse: Reverse B Versions: 1901/6A.1.1 Pierced 1901/6A.1.2 Unpierced</p>		
	<p>[1901/6A.1.2]</p>	

1901/8



Diameter: 27 mm, pierced and unpierced
 Metal: Copper, thick and thin versions reported
 Rarity: R1



[1901/8.1]

Obverse: Obverse 2

Reverse: Reverse A

Note: On some examples, the comma after OPHIR may look more like a dot, or be very faint.

- Versions:
- 1901/8.1 Silver
 - 1901/8.4.1 Copper, thick flan, pierced
 - 1901/8.4.1A Copper, thick flan, unpierced
 - 1901/8.4.2 Copper, thin flan



[1901/8.4.1]



[1901/8.4.1A]



[1901/8.4.2]



Note: No. 1901/7 has been retired.

1901/9

[illustration unavailable]

Diameter: 27 mm, pierced
Metal: Silvered, Copper
Rarity: Both R2

[illustration unavailable]

[1901/9.2]

Obverse: Obverse 3
Reverse: Reverse C
Versions: 1901/9.2 Silvered
 1901/9.4 Copper



[1901/9.4]



	<p>1901/9A (1901/10)</p>	
	<p>Diameter: 27 mm Metal: Silvered, Gilt, Copper, thick (2.5 mm, 11.25 g) and thin versions reported Rarity: R4 [1901/9A.2]</p>	
<p>Obverse: Obverse 3</p>		
<p>Reverse: Reverse D</p>		
<p>Note: Dots around period at base of reverse may be very faint, and the apostrophe in CHILDREN'S may be faint or even absent</p>		
<p>Versions: 1901/9A.2 Silvered (pierced) 1901/9A.3 Gilt (unpierced) 1901/9A.4.1 Copper (pierced, flan 2.5 mm thick, 11.25 g) 1901/9A.4.2 Copper (pierced, thinner, lighter flan)</p>		
	<p>[1901/9A.3]</p>	
	<p>[1901/9A.4.1 or 4.2]</p>	



1901/9B
(1901/11)

Diameter: 27 mm
Metal: Silver, Gilt,
Copper, Silvered
Rarity: R5, R5, R1, R7?



[1901/9B.1]

Obverse: Obverse 4
Reverse: Reverse D
Versions: 1901/9B.1 Silver, pierced
1901/9B.3 Gilt, pierced and loop suspension noted
1901/9B.4.1 Copper, thick flan (2.37 mm, 10.80 g)
1901/9B.4.2 Copper, thin flan (2.25 mm, 10.35 g)





[1901/9B.3]





[1901/9B.4.1 or 4.2]
Ribbon presumably not standard



Commemorative Medals – 1900s

	1901/9C (-)	
	Diameter: 27 mm, pierced Metal: Copper Rarity: R5	
[1901/9C.4]		
Obverse: Obverse 4 Reverse: Reverse A Versions: 1901/9C.4	Copper, pierced	

	1901/9D (1901/12)	
	Diameter: 27 mm, pierced Metal: Copper Rarity: R4	
[1901/9D.4]		
Obverse: Obverse 5 Reverse: Reverse D Versions: 1901/9D.4	Copper, pierced	

1901/9E
(1901/13)

[illustration unavailable]

Diameter: 27 mm
Metal: Silver, Gilt,
Copper, Chromed
Rarity: R5, R2, R1, R4

[illustration unavailable]

[1901/9E.1]

Obverse: Obverse 6

Reverse: Reverse E

Versions: 1901/9E.1

1901/9E.3

1901/9E.4

1901/9E.5

Silver

Gilt (unpierced)

Copper (pierced)

Chromed (pierced)



[1901/9E.3]



[1901/9E.4]



[1901/9E.5]



Commemorative Medals – 1900s



1901/9F
(1901/14)

Diameter: 27 mm, pierced,
loop suspension
Metal: Gilt, Copper
Rarity: R3

[1901/9F.3]

Obverse: Obverse 6
Reverse: Reverse F
Versions: 1901/9F.3 Gilt
1901/9F.4 Copper (pierced)

[1901/9F.4]



1901/9G
(-)



Diameter: 27 mm
Metal: Copper
Rarity: R7

Struck from two Obverse 3 dies; “reverse” overstruck on an unidentified reverse type. Legends on reverse poorly struck up.

Versions: 1901/9G.4 Copper

Note: Nos. 1901/10-14 have been retired.

Commemorative Medals – 1900s

	<p>1901/15 (-)</p> <p>Diameter: 27 mm Metal: Silver Rarity: R6 Designer: E. Fuchs Reference: BHM 3722</p>	
<p>Obverse: Crowned anchor with garter emblem (cf. 1901/5). Inscr around T.R.H.S THE DUKE & DUCHESS OF YORK'S VISIT TO THE COLONIES; 1901 below</p> <p>Reverse: Conjoined effigies of Duke and Duchess of York and Cambridge facing L; E. FUCHS / 1901 to R.</p>		

1902/1 (Transvaal Peace/Queen Victoria) has been moved to the "undated" chapter since this medal does not carry a date and its date attribution is uncertain (Victoria died in 1901, and the medal could possibly have been a premature issue – cf. 1900/35 and 35A, and also the early version of the Queen's South Africa Medal dated 1899-1900).

PETONE RAILWAY WORKSHOPS PEACE DEMONSTRATION 1902

1902/2



Diameter: 35.5 mm, pierced & unpierced
 Metal: Lead, Brass, silvered lead
 Rarity: R5, R6, R7



[1902/2.1]

Obverse: Cross shape in centre. Inscr around above . PEACE . and around below DEMONSTRATION; outer circle of text around *. * PETONE RAILWAY WORKSHOPS * . *

Reverse: Locomotive to R in wreath of disjointed branches; 11.6.1902. around above

Versions: 1902/2.1 Lead
 1902/2.2 Brass
 1902/2.3 Silvered lead



[1902/2.2]



[illustration unavailable]

[1902/2.3]

[illustration unavailable]

1902/3 (J.R. Montague/Return of NZ Contingent from Transvaal) has been moved to the “undated” chapter since this medal does not carry a date and its date attribution is uncertain (Montague died in 1901, and the medal could possibly mark the return of the 1st NZ Contingent in late 1900).

END OF BOER WAR AND CORONATION OF EDWARD VII 1902

1902/4

[illustration unavailable]

Diameter: 22.5 x 25 mm,
cross shaped,
loop suspension
Metal: Silver, Gilt
Rarity: Both R5
Maker: Stokes

[illustration unavailable]

[1902/4.1]

Obverse: Crowned ER VII monogram in centre. Inscr BRITISH / - BOER / WAR at L; PEACE / WITH / HONOR (sic) at R, and 1902 at base

Reverse: Crowned effigy of Edward VII (1841-1910) ½ facing L. Inscr side-on in left arm of cross CORONAT- / - ION OF; at top EDWARD / VII; side-on at R & ALEXAN / -DRA; and at base . 1902. / JUNE .26

Note: Also listed in Carlisle as C#1902/5a. For an item with a similar shape and an August coronation date, see 1902/4A

Versions: 1902/4.1 Silver
1902/4.2 Gilt



[1902/4.2]



CORONATION OF EDWARD VII 1902

1902/4A

(1902/9)

[illustration unavailable]

Diameter: 22.5 x 25 mm,
cross shaped,
loop suspension

Metal: Silver, Gilt Silver

Rarity: R4 (both)

[illustration unavailable]

[1902/4A.1]

Obverse: Crowned ER VII monogram in centre; inscr at L NEW / ZEALAND; at R CELEBR- / ATIONS and 1902 at base

Reverse: Like 1902/4 except date now AUG. 9- / -1902-

Versions: 1902/4A.1 Silver
1902/4A.2 Gilt silver



[1902/4A.2]



1902/4B



Diameter: 22.5 x 25 mm,
cross shaped,
incomplete
suspension loop

Metal: Silver, Gilt

Rarity: Both R5

Maker: Stokes



Obverse: Crowned ER VII monogram in centre; inscr at L NEW / ZEALAND; at R CELEBR- / ATIONS and 1902 at base

Reverse: BIRCHIP / SHIRE / -- / PRES. / JOS. LOCKWOOD (curved) / COUNCILLORS / G. GOUDIN, W. BARBER, F. SCOTT / J. SPITTLE, T. JESS, S.W. FIELDING / J.P. NEYLAND, E.J. BOLTON / -- / ENG. / A.G. STEWART (curved) / SEC. / ROB. GORRIE

Note: In Carlisle as C#1902/5b. Mule of 1902/4A.2 and an Australian issue, C#1902/5

Commemorative Medals – 1900s

1902/5



Diameter: 38 mm, pierced
Metal: Aluminium
Rarity: R6

A colonial issue



Obverse: In dotted circle, crowned arms of the UK in wreath with crossed sceptres behind. Inscr around above TO COMMEMORATE THEIR MAJESTIES CORONATION and around below . JUNE 26TH 1902 .

Reverse: Conjoined busts of King Edward VII (1841-1910) and Queen Alexandra (1844-1925) to R, branch below. Inscr around above KING EDWARD VII + QUEEN ALEXANDRA

Note: Leaf under K of KING; ribbon under last A of ALEXANDRA; Queen's nose to letter L

1902/5.1
(-)



Diameter: 38 mm, unpierced
Metal: Aluminium
Rarity: R6

A colonial issue



Obverse: Like 1902/5
Reverse: Like 1902/5
Note: Leaf and ribbon position similar to 1902/5. H. G. in small letters below

1902/5A
(-)



Diameter: 38 mm, pierced
Metal: Aluminium
Rarity: R6

A colonial issue



Obverse: Like 1902/5
Reverse: Like 1902/5
Note: Leaf under left vertical of K in KING; ribbon away from last A of ALEXANDRA
Queen's nose between L and E

Commemorative Medals – 1900s





Obverse: Like 1902/5
Reverse: Like 1902/5
Note: Leaf and ribbon position similar to 1902/5A. H. GRUEBER, LONDON. in small letters below

1902/5A.1
(-)

Diameter: 38 mm, pierced
Metal: Aluminium
Rarity: R6

A colonial issue







Obverse: Like 1902/5
Reverse: Like 1902/5
Note: Leaf not quite under left vertical of K in KING; ribbon close to last A of ALEXANDRA; Queen's nose between L and E

1902/5B
(-)

Diameter: 38 mm, pierced
Metal: Aluminium
Rarity: R6

A colonial issue





Obverse: Like 1902/5
Reverse: Like 1902/5
Note: Leaf away from K, touches truncation; ribbon points to mid-way up last A of ALEXANDRA. Queen's nose between L and E. Larger effigies: truncation almost touches K

1902/5C
(-)

Diameter: 38 mm, pierced
Metal: Aluminium
Rarity: R6

A colonial issue



1902/6



[1902/6.1]

Obverse: Two shields with single crown above, two forearms performing handshake below; ribbon beneath reading CROWNED 1902, the whole in a wreath. Inscr around EDWARD VII KING OF GREAT BRITAIN & COLONIES & EMPEROR OF INDIA



Reverse: Edward VII to R; SWAN below shoulder; ER in field at L, 1901 at R. Inscr around above EDWARD VII KING & EMPEROR and around below .. GOD SAVE THE KING ..

Versions: 1902/6.1 Gilt
1902/6.2 White metal



[1902/6.2]

1902/6A
(1902/20)





Obverse: Inscr in centre -- / .. 26TH .. JUNE .. 1902. / -- / * CELEBRATED * / + AT + / BLUFF HARBOUR -- / <- N.Z. ->
CORONATION DAY around above

Reverse: Like 1902/6

Diameter: 27 mm, loop suspension
Metal: White metal
Rarity: R6
Maker: J. Swan & Co.

Commemorative Medals – 1900s

	<p>1902/7</p> <p>Diameter: 15 mm, loop suspension</p> <p>Metal: Silver, Gilt</p> <p>Rarity: Both R6</p> <p>Maker: A. Kohn, Auckland</p> <p>[1902/7.1]</p>	
<p>Obverse: Inscr in centre * / JUNE / 26TH, around above CORONATION and around below * 1902 *, in minute letters at base A KOHN</p> <p>Reverse: Bare head of Edward VII to R</p> <p>Versions: 1902/7.1 Silver 1902/7.2 Gilt</p>		
<p>[illustration unavailable]</p>	<p>[1902/7.2]</p>	<p>[illustration unavailable]</p>

	<p>1902/7A (1902/8)</p> <p>Diameter: 15 mm, loop suspension</p> <p>Metal: Silver, Gilt silver</p> <p>Rarity: Both R5</p> <p>[1902/7A.1]</p>	
<p>Obverse: Like 1902/7 but date changed to * / AUGUST / 9TH</p> <p>Reverse: Like 1902/7</p> <p>Versions: 1902/7A.1 Silver 1902/7A.2 Gilt silver</p>		
<p>[illustration unavailable]</p>	<p>[1902/7A.2]</p>	<p>[illustration unavailable]</p>

1902/10



Diameter: 22 mm,
milled edge,
loop suspension

Metal: Brass

Rarity: R2

**Probably for general
colonial use**



Obverse: Crown in centre; in arches busts of Edward VII and Alexandra facing. CORONATION above, 1902 below. In small letters around lower rim MADE IN GERMANY; left base of crown between E and I

Reverse: Two globes showing western and eastern hemispheres in centre; BRITISH EMPIRE in curved text below. Inscr above BARRATT / & CO'S and below SWEETS / ARE PURE

Note: Reverse like 1897/5 but second S of SWEETS over E

1902/10A
(1902/21)



Diameter: 22 mm,
loop suspension

Metal: Brass

Rarity: R2

**Probably for general
colonial use**



Obverse: Like 1902/10 but rim of crown opposite E of MADE

Reverse: Like 1897/5 (second S of SWEETS over R)

1902/10B
(1902/11)



Diameter: 22 mm,
loop suspension

Metal: Brass

Rarity: R2

**Probably for general
colonial use**



Obverse: Like 1902/10 but without MADE IN GERMANY

Reverse: Like 1897/5 (second S of SWEETS over R)

Note: Nos. 1902/9, 9 and 11 have been retired.

1902/12 – 1902/17

OVERVIEW OF OBTVERSE AND REVERSE TYPES

(Only key distinguishing features noted here; see item descriptions on following pages for full details)



Obv. 1
NEW ZEALAND
curves up at
centre
(date 26.6)



Obv. 2
26.6 of date
obliterated



Obv. 3
NEW ZEALAND in
ribbon, curves
down at centre
(date 9.8)



Obv. 4
HMS Victory



Obv. 5
Plain obverse for
engraving



Rev. A
Plain rim, no side
ornaments
EDWARD . VII .
AND ALEXANDRA
/ CROWNED 26
JUNE / 1902



Rev. B
Plain rim, no side
ornaments
ALEXANDRA *
CORONATION *
EDWARD VII /
1902 / *



Rev. C
Rim with side
ornaments at
10:00 and 2:00
Dots before
EDWARD and
after ALEXANDRA
Otherwise as
Rev. A



Rev. D
Rim with side
ornaments at
10:00 and 2:00
EDWARD VII.
AND ALEXANDRA
. CROWNED /
1902



Rev. E
Rim with side
ornaments at
10:00 and 2:00
As Rev. A but
date now .9. AUG
/ 1902

Note: Maker presumably Stokes, since the blanks match those used for 1906-07/1

Commemorative Medals – 1900s

	<p>1902/12</p>	
<p>Diameter: 38 x 26.5 mm, loop suspension, crowned shield shape</p> <p>Metal: Gilt, Silvered, Bronze</p> <p>Rarity: R4 (all)</p>		
<p>[1902/12.1]</p>		
<p>Obverse: Obverse 1: Inscr <u>EDWARD VII</u> / KING AND EMPEROR / ASCENSION , 22 . 1 . 1901 / CORONATION , 26 . 6 . 1902 / –. – / GOD SAVE THE KING (line with scrolled ends below) / NEW ZEALAND / . * . / CELEBRATIONS</p>		
<p>Reverse: Reverse A: Conjoined busts of Edward VII and Alexandra to L in circle. Inscr around above EDWARD . VII . AND ALEXANDRA and around below CROWNED 26 JUNE / 1902</p>		
<p>Versions: 1902/12.1 Gilt 1902/12.2 Silvered 1902/12.3 Bronze</p>		
	<p>[1902/12.2]</p>	
	<p>[1902/12.3]</p>	

	<p>1902/12A (1902/13)</p>							
	<p>Diameter: 39 x 26.5 mm, loop suspension, crowned shield shape</p> <p>Metal: Gilt, Silvered, Bronze</p> <p>Rarity: R4 (all)</p>							
	<p>[1902/12A.1]</p>							
<p>Obverse: Obverse 1 Reverse: Reverse B: Like 1902/12 but inscr around above ALEXANDRA * CORONATION * EDWARD VII and below 1902 / *</p> <table border="0"> <tr> <td data-bbox="204 734 499 766">Versions: 1902/12A.1</td> <td data-bbox="555 734 595 766">Gilt</td> </tr> <tr> <td data-bbox="355 772 499 804">1902/12A.2</td> <td data-bbox="555 772 647 804">Silvered</td> </tr> <tr> <td data-bbox="355 810 499 842">1902/12A.3</td> <td data-bbox="555 810 639 842">Bronze</td> </tr> </table>	Versions: 1902/12A.1	Gilt	1902/12A.2	Silvered	1902/12A.3	Bronze		
Versions: 1902/12A.1	Gilt							
1902/12A.2	Silvered							
1902/12A.3	Bronze							
	<p>[1902/12A.2]</p>							
	<p>[1902/12A.3]</p>							

Commemorative Medals – 1900s

1902/14



Diameter: 39 x 26.5 mm,
loop suspension,
crowned shield
shape

Metal: Copper

Rarity: R7



Obverse: Obverse 2: Like 1902/12A but 26 . 6 . of date obliterated with fern leaf counterstamp.
Reverse: Reverse B

1902/15



Diameter: 39 x 26.5 mm,
loop suspension,
crowned shield
shape

Metal: Gilt

Rarity: R6



Obverse: Obverse 3: Inscr EDWARD VII / KING AND EMPEROR / ACCESSION , 22 . 1 . 1901 / CORONATION , 9 . 8 . 1902 (line with scrolled ends below) / GOD SAVE THE KING / NEW ZEALAND / CELEBRATIONS [Note: NEW ZEALAND now on ribbon and curves downward in the middle, unlike 1902/12]

Reverse: Reverse D: Conjoined busts of Edward VII and Alexandra to L in circle. Inscr around above EDWARD VII . AND ALEXANDRA . CROWNED and below 1902

1902/15A
(1902/16)



Diameter: 39 x 26.5 mm,
loop suspension,
crowned shield
shape

Metal: Gilt

Rarity: R6



Obverse: Obverse 3
Reverse: Reverse E: Conjoined busts of Edward VII and Alexandra to L in circle. Inscr around above EDWARD VII . AND ALEXANDRA and around below CROWNED .9. AUG. / 1902

Commemorative Medals – 1900s

1902/17



Diameter: 39 x 26.5 mm,
loop suspension,
crowned shield
shape
Metal: Gilt, Silvered,
Bronze
Rarity: All R3



[1902/17.1]

Obverse: Obverse 4: Nelson's ship Victory to R. Inscr VICTORY on hull. Inscr around above NELSON'S CELEBRATIONS and around below PALMAM QUI MERUIT FERAT (Nelson's motto: "Let him bear away the palm who has deserved it")

Reverse: Reverse A

Versions: 1902/17.1 Gilt
1902/17.2 Silvered
1902/17.3 Bronze



[1902/17.2]



[1902/17.3]



1902/17A

(-)

[illustration unavailable]

Diameter: 39 x 26.5 mm,
loop suspension,
crowned shield
shape

[illustration unavailable]

Metal: Gilt, Silvered,
Bronze

Rarity: All R3

[1902/17A.1]

Obverse: Obverse 4

Reverse: Reverse C: Like Reverse A, but dot before EDWARD and after ALEXANDRA, and extra ornament on rim projecting toward W of EDWARD and D of ALEXANDRA

Versions: 1902/17A.1 Gilt
1902/17A.2 Silvered
1902/17A.3 Bronze



[1902/17A.2]



[illustration unavailable]

[1902/17A.3]



[illustration unavailable]



Commemorative Medals – 1900s

	<p>1902/17B (1902/18)</p>	
<p>Diameter: 39 x 26.5 mm, loop suspension, crowned shield shape</p> <p>Metal: Silver, Silvered</p> <p>Rarity: R5</p>		
<p>[1902/17B.1]</p>		
<p>Obverse: Obverse 4 Reverse: Reverse E Versions: 1902/17B.1 Silver 1902/17B.2 Silvered</p>		
	<p>[1902/17B.2]</p>	

	<p>1902/17C (-)</p>	
<p>Diameter: 39 x 26.5 mm, loop suspension, crowned shield shape</p> <p>Metal: Silvered?</p> <p>Rarity: R7</p>		
<p>Obverse: Obverse 5: Engraved SPORTS / 100 YDS RACE / -> WON BY <- / J. GOW Reverse: Reverse C</p>		

Note: Nos. 1902/13, 16 and 18 have been retired.

	<p>1902/19</p> <p>Diameter: 21.25 mm, loop suspension</p> <p>Metal: Silver</p> <p>Rarity: R5</p>	
<p>Obverse: Inscr LAWRENCE (curved) / (ornament) / CORONATION / (dotted and dashed line) / CELEBRATIONS / ..*.. / * 1902. *</p> <p>Reverse: Edward VII to R. Inscr around above EDWARD VII KING & EMPEROR and around below * CROWNED AUG. 1902*</p>		

	<p>1902/22 (-)</p> <p>Diameter: 23.5 mm, loop suspension</p> <p>Edge: Plain</p> <p>Metal: Silver</p> <p>Rarity: R7</p>	
<p>Obverse: Engraved CORONATION / KING EDWARD VII / 9.8.1902 (between leaves) / - NEVIS - / N.Z.</p> <p>Reverse: Engraved HM°C. Maker's mark stamped HISLOP in incuse rectangle below.</p> <p>Note: Leaves possibly obscure 2 of earlier date (26.6) – re-engraved?</p>		

Note: Nos. 1902/20 and 21 have been retired.

STRATFORD TECHNICAL EXHIBITION 1903



1903/1

Diameter: 23 mm
Metal: Silver, loop
suspension (not
shown in image)
Rarity: R6



Obverse: Ornamental pattern, above which inscr STRATFORD TECHNICAL in semicircle; below pattern inscr EXHIBITION / : WON BY : and blank field for engraving

Reverse: Front view of school building, date 1903 below in ornamental pattern

Note: Stratford District High School was established in 1897. Known later as the Stratford Technical High School, since 1966 it has been simply Stratford High School

WESTPORT INDUSTRIAL MINING EXHIBITION 1904



1904/1

Diameter: 17.25 mm,
loop suspension
Metal: Silver, Copper
Rarity: R5, R5



[1904/1.1]

Obverse: Inscr INDUSTRIAL / & MINING ∴ / EXHIBITION (decorative features between lines of text); WESTPORT around above, around below ∴ 1904 ∴

Reverse: Kiwi to R with coastline and palm trees, water to R with mounds in background

Versions: 1904/1.1 Silver

1904/1.2 Copper (loop suspension probably broken off in illustrated example)



[1904/1.2]



HAWERA EXHIBITION 1904

Opened on 3 February by Premier Richard John Seddon, the exhibition was housed in a collection of buildings known as the “Corridor”. A small profit was made by the end of the exhibition on 13 February, and a portion of the profit was allocated to the town’s hospital while a further sum was spent on installing gates for King Edward Park.



1904/2

Diameter: 19.5 mm, pierced,
loop suspension
Metal: Silver, Gilt,
Copper
Rarity: R6, R4, R4



[1904/2.1]

Obverse: Mount Taranaki (formerly Mt. Egmont). Inscr HAWERA EXHIBITION around above; MT. EGMONT / 1904 in exergue

Reverse: Wreath in centre; inscr EXHIBITION SOUVENIR around above (cf. 1904/4, 1904/5 and 1906-07/3)

Note: Medal examined in National Museum was struck over an old head sixpence of Queen Victoria (Leon Morel)

Versions: 1904/2.1 Silver
1904/2.2 Gilt
1904/2.3 Copper



[1904/2.2]



[1904/2.3]





1904/3

Diameter: 17 mm, pierced
Metal: Silver
Rarity: R4



Obverse: Inscr HAWERA INDUSTRIAL around at top; EXHIBITION / - 1904 - in centre with floral decoration above; crossed fern leaves at base
Reverse: Exhibition building

MARLBOROUGH EXHIBITION 1904

According to the Evening Post of 20 September 1904, entry was a prohibitive 2/6d on the opening afternoon and evening (over \$25 today!). The cost of running the two-week exhibition, including buildings, was £2,400 and after sale was expected to have a credit balance.

From *Marlborough Online*: The Marlborough Exhibition was opened in Blenheim by the Governor, Lord Plunket. There were many entries of machinery, historic objects, and displays. Many national firms exhibited. There were competitions, concerts and side shows. It ran for two weeks and proved a splendid success.

1904/4



Diameter: 16.5 mm, pierced
(silver version
with loop also
noted)
Metal: Silver, Gilt, Bronze
Rarity: All R5



[1904/4.1.1]

Obverse: Exhibition buildings; inscr MARLBOROUGH EXHIBITION around above, – 1904 – / - . - in exergue

Reverse: Open wreath; inscr EXHIBITION SOUVENIR around above (like 1904/2 and 1904/5)

Versions: 1904/4.1.1 Silver, pierced
1904/4.1.2 Silver, loop
1904/4.2 Gilt
1904/4.3 Bronze



[1904/4.1.2]



Commemorative Medals – 1900s



[1904/4.2]



[illustration unavailable]

[1904/4.3]

[illustration unavailable]

NEW PLYMOUTH EXHIBITION 1904

1904/5



Diameter: 16.5 mm, pierced,
loop suspension
Metal: Silver, Copper,
Aluminium
Rarity: All R6



[1904/5.1]

Obverse: Mount Taranaki (formerly Mt. Egmont) with Exhibition buildings in foreground. Inscr NEW PLYMOUTH / 1904 in exergue; EXHIBITION & CARNIVAL around above

Reverse: Like 1904/2 and 1904/4

Versions: 1904/5.1 Silver (loop)
1904/5.2 Copper (pierced)
1904/5.3 Aluminium (pierced)



[1904/5.2]



[1904/5.3]





1904/6

Diameter: 23.5 mm, pierced & unpierced
 Metal: Gold, Silver, Copper, Silvered copper
 Rarity: R7, R3, R2



[1904/6.1]

Obverse: In centre circle, four vessels in harbour, steamer beyond two rocks (Moturoa and Paritutu). NEW PLYMOUTH EXHIBITION OF ART & INDUSTRIES around above, . 1904 . below

Reverse: Perspective view of Poet's Bridge and Mt Taranaki (Pukekura Park, New Plymouth)

Versions: 1904/6.1 Gold (assumed 18ct, recorded as 23 mm)
 1904/6.2 Silver
 1904/6.3 Copper
 1904/6.4 Silvered copper



[1904/6.2]



[1904/6.3]



Commemorative Medals – 1900s

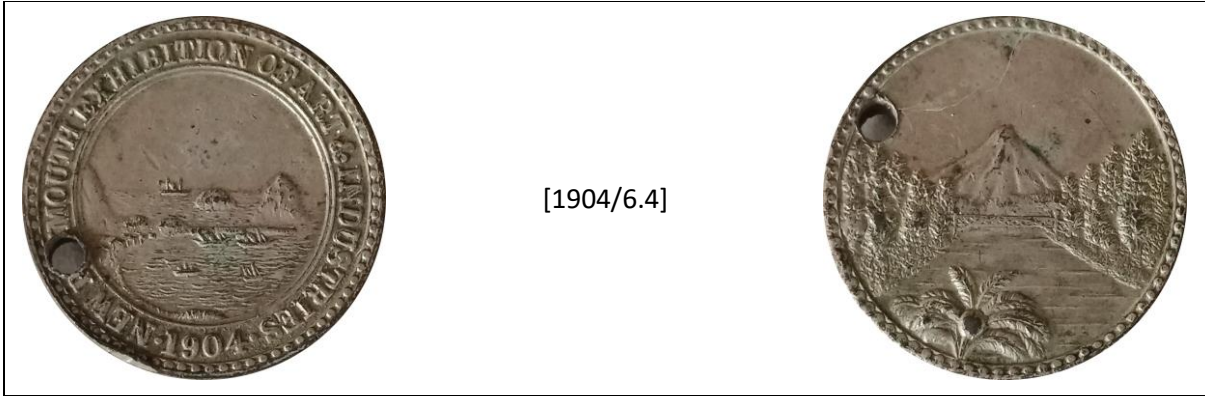

[1904/6.4]

1904/7

[illustration unavailable]

Diameter: 23.5 mm,
unpierced
Metal: Gold, Silver,
Copper
Rarity: R7, R6, R6

[illustration unavailable]

[1904/7.1]

Obverse: Like 1904/6 but centre field blank for engraving. Inscr at top centre field AWARDED TO

Reverse: Like 1904/6

Versions: 1904/7.1 Gold
1904/7.2 Silver
1904/7.3 Copper



[1904/7.2]



[illustration unavailable]

[1904/7.3]

[illustration unavailable]

JOSEPH NATHAN LTD CALENDAR MEDAL 1904

Joseph Nathan Ltd were merchants occupying the fourth floor of Nathan's Buildings, on the corner of Featherston and Grey St, Wellington.



1904/8

Diameter: 38 mm,
milled edge
Metal: Aluminium
Rarity: R5



Obverse: Cockerel to R. Inscr in two concentric lines around above NOTHING TO EQUAL DEFIANCE BRAND / BUTTER AND DRIED MILK and around below PROPRIETORS / . JOSEPH NATHAN & CO. LTD. WELLINGTON .

Reverse: Calendar wheel with rotating upper section. Years 1904 to 1925 arranged anticlockwise around outer circle behind; abbreviated month names in seven sections on rotating component. In centre PATENT APPLIED FOR; in next outer ring CALENDAR around above and . 1904 to 1925 . below; inscr in three rows around at left TO SET THE CALENDAR / BRING REQUIRED MONTH / IN LINE WITH YEAR. In three rows around at right THE UNDERLINED JAN. & FEB. / TO BE USED ONLY / IN LEAP YEARS.

Reference: Also Gottermeyer N2 in John Bertrand listing of special-purpose tokens. Cf M1906-07/18A (G#N2a) for a related obverse design



1904/8A

Diameter: 38 mm,
milled edge
Metal: Aluminium
Rarity: R5



Obverse: Edward VII, bare head to R. Inscr around EDWARD VII KING AND EMPEROR . . .

Reverse: Like 1904/8

Note: Probably a UK/Empire issue

Commemorative Medals – 1900s



1904/8B

Diameter: 38 mm,
milled edge
Metal: Aluminium
Rarity: R5



Obverse: Bust of Lord Nelson (1759-1805) to L; NELSON . CENTENARY . 1805-1905 around above; wreath below

Reverse: Like 1904/8

Note: Probably a UK/Empire issue; included here rather than 1905 because of the common reverse design shared with 1904/8 and 1904/8A

**MEETING OF LORD RANFURLY WITH THE PRINCIPAL CHIEFS OF
NEW ZEALAND AT RUATOKI, 1904**



1904/9
(-)

Diameter: 55 x 38 mm
Metal: Silver, loop suspension
Rarity: R5 (14 made, individual named versions unique)



Obverse: Arms of Lord Ranfurly (1856-1933, Governor of New Zealand 1897-1904). Engraved above RUATOKI / March 16, 1904 and below Ranfurly / GOVERNOR / 1897 to 1904

Reverse: Inscr MALCOLM ROSS / Hei whakamaharatanga / ki te Hui nui. / Na tetahi hoa / pono o te / Iwi Maori, with decorative elements around [*In remembrance of the great gathering, from a true friend of the Māori people*].

Note: Engraved on a stock medal hallmarked London 1904. The 13 named awardees (excluding Ross) are: Hon James Carroll; Captain Gilbert Mair NZC; Dr Pomare; Te Maikowha; Tupaea; Te Amo; Tutakangahau; Te Tuhi Pihopa; Paora Kingi; Te Hurinui Apanui; Tana Rakuvaku [sic]; Te Whenuanui; and Numia Kereru. The James Carroll example is held by Te Papa

**BRITISH FOREIGN SAILORS SOCIETY
NELSON CENTENARY COMMEMORATIVE 1905
HMS VICTORY**

Note: for a 38 mm aluminium medal showing Nelson with a 1904-1925 calendar reverse, see M1904/8B

1905/1



Diameter: 16.5 mm,
loop suspension
Metal: Copper
Rarity: R1

Issued throughout the Empire

[1905/1.1]



Obverse: FROM / B.F.S.S. / NELSON CENTENARY / CONTAINING / VICTORY COPPER / E.R. VII (bar below stops left of V)

Reverse: HMS Victory to R. Inscr VICTORY / 1905 in exergue

Versions: 1905/1.1 16.5 mm

1905/1.2 11 mm (diameter reported but not confirmed)



[1905/1.2]





[1905/1A]

1905/1A
(1905/2)

Diameter: 16.5 mm, loop suspension; some with no suspension but elaborate diamond scroll surround

Metal: Copper
Rarity: R4

[1A.1]



[1905/1A]

Issued throughout the Empire

Obverse: Like 1905/1
Reverse: Like 1905/1 but vessel to left, furlled sails, 1 under C
Versions: 1905/1A.1 Copper, normal diameter
1905/1A.2 Copper, in elaborate diamond-shaped scroll surround (see also 1905/1C.3 and 1905/4E)



[1905/1A.2]

[Image credit: oldcopper.org]



[Image credit: oldcopper.org]



[1905/1B.1]

1905/1B
(1905/3)

Diameter: 19 mm
Metal: Copper
Rarity: R3

[1905/1B.1]



Issued throughout the Empire

Obverse: FROM / B.F.S.S. / NELSON CENTENARY / CONTAINING / VICTORY COPPER / E.R. VII. (bar below continues under V)
Reverse: Like 1905/1A but 1 under right of C
Versions: 1905/1B.1 Round
1905/1B.2 In floral surround (overall diameter unknown)

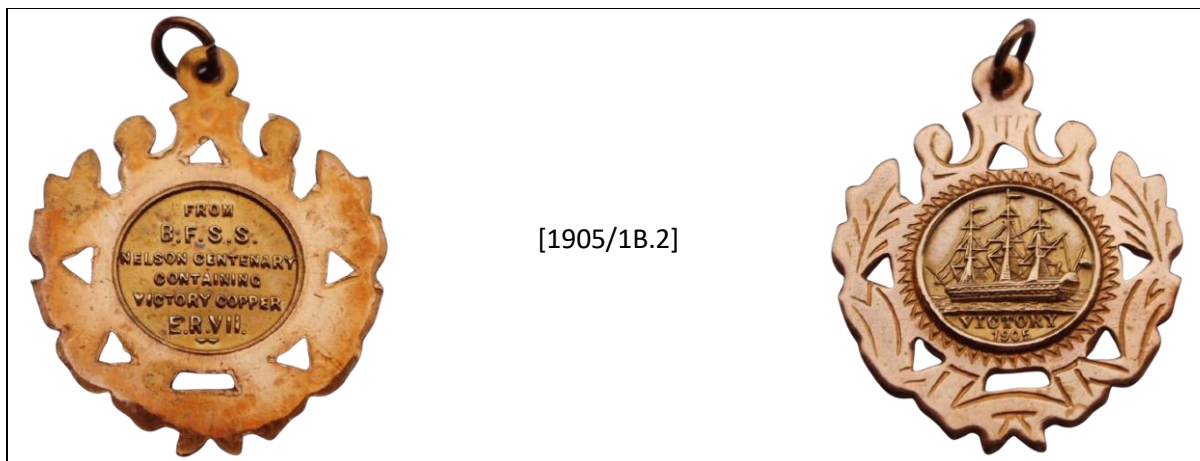

[1905/1B.2]

1905/1C

(-)



Diameter: 16.5 mm. Loop suspension, or no suspension but elaborate diamond scroll surround

Metal: Copper, Copper Gilt

Rarity: R3



[1905/1C.1]

Issued throughout the Empire

Obverse: In centre inscr COPPER / FROM / NELSON'S SHIPS / E.R. VII ; inscr around BRITISH AND FOREIGN SAILORS SOCIETY -*-

Reverse: Like 1905/1A

- Versions:
- 1905/1C.1 Copper, normal diameter
 - 1905/1C.2 Copper-gilt, normal diameter
 - 1905/1C.3 Copper, in elaborate diamond-shaped surround, 32 x 32 mm



[1905/1C.2]



Commemorative Medals – 1900s

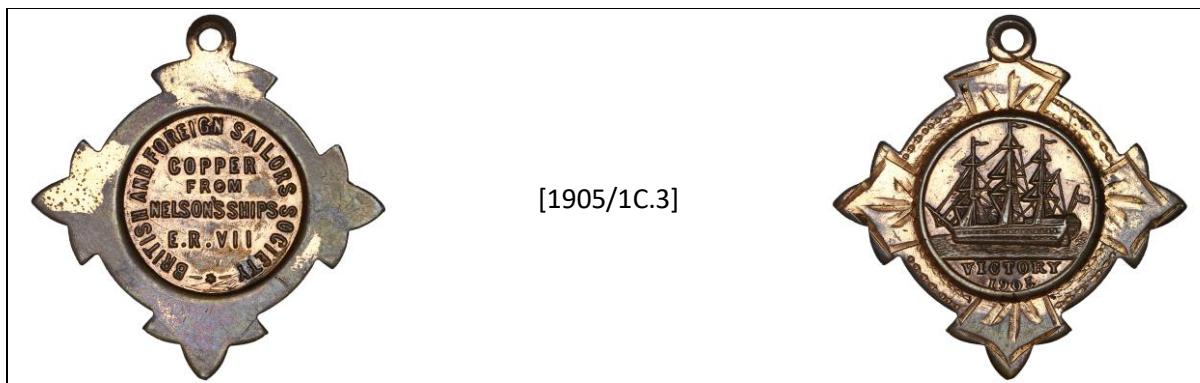

[1905/1C.3]



1905/1D

(-)



Diameter: 28.5 mm
Metal: Copper
Rarity: R3

[1905/1D.1]

Issued throughout the Empire

- Obverse:** In centre circle Nelson standing to L; inscr on ribbon below DEATH OF NELSON OCT.21.1805 CENTENARY. MEMENTO OCT.21. 1905. E.R. VII below ribbon. In outer circle inscr around above PRESENTED BY BRITISH & FOREIGN SAILORS SOCIETY and around below . CONTAINING VICTORY COPPER FROM LORDS OF THE ADMIRALTY .
- Reverse:** In centre circle HMS Victory to R. Inscr VICTORY . TRAFALGAR / OCT. 21 . 1805 below. In outer circle inscr around above "ENGLAND EXPECTS THAT EV [circle] ERY MAN WILL DO HIS DUTY" and around below "THANK GOD I HAVE DONE MY DUTY"
- Note:** Small circle between V and E in EV ERY is a guide for piercing
- Versions:** 1905/1D.1 Unpierced
1905/1D.2 Pierced

Commemorative Medals – 1900s

	<p>1905/1E (-)</p>	
	<p>Diameter: unknown Metal: Copper Rarity: -</p>	
	<p>[1905/1E.2]</p>	
	<p>Issued throughout the Empire</p>	
<p>Obverse: FROM / B.F.S.S. / NELSON CENTENARY / CONTAINING / VICTORY COPPER / E.R. VII (no bar below)</p>		
<p>Reverse: Like 1905/1A but VICTORY in exergue (no date)</p>		
<p>Versions: <i>1905/1E.1 Reserved for plain round version if discovered</i> <i>1905/1E.2 In floral surround (overall diameter unknown)</i></p>		
<p>Note: Although undated, this is included with the related items in the series</p>		

Note: Nos. 1905/2 and 3 have been retired.

NELSON CENTENARY COMMEMORATIVE 1905

HMS FOUDROYANT

See note to 1905/4D below. Although undated, these are included at this point because of their obvious kinship with the 1905 Nelson/HMS Victory issues. At least some would have been made in 1897, when the 'Foudroyant' was wrecked

	<p>1905/4A (-)</p>	
	<p>Diameter: 19 mm, loop suspension Metal: Copper Rarity: R3</p>	
	<p>Issued throughout the Empire</p>	
<p>Obverse: Inscr MADE FROM (curved) / COPPER BOLT / FROM / NELSON'S / FLAGSHIP / FOUDROYANT (curved) Reverse: HMS Foudroyant to L, inscr FOUDROYANT on curved ribbon below</p>		

	<p>1905/4D (F/1)</p>	
	<p>Diameter: 37.5 mm Metal: Copper Rarity: R5</p>	
	<p>Issued throughout the Empire</p>	
<p>Obverse: Bust of Horatio, Viscount Nelson (1758-1805) ½ L. Inscr * HORATIO. VISCOUNT NELSON * around above; inscr in two horizontal lines below BORN, 29TH SEPTEMBER, 1758 / DIED, 21ST OCTOBER, 1805; in small letters around rim at base REG. No. 311490 Reverse: HMS Foudroyant to L. Inscr "FOUDROYANT", LORD NELSON'S "FLAGSHIP" around above; inscr in four horizontal lines below COMMENCED BUILDING, 1789, / LAUNCHED AT PLYMOUTH, 1798 / WRECKED AT BLACKPOOL / JUNE 16TH, 1897. In small letters around below MEDAL STRUCK FROM COPPER OF VESSEL AFTER BREAKING UP Note: Undated but actually struck in 1897, based on registered design number (cf. oldcopper.org). <i>Note by Leon Morel to F/1 in the 2000 Supplement:</i> "This medal was listed in the 1976 edition but deleted in the 1996 edition. Conclusive evidence has been found, however, that this medal was sold along with [1905/1, 1A and 1B] by the British and Foreign Sailors' Society at the 1906-07 New Zealand International Exhibition in Christchurch."</p>		

**NELSON CENTENARY COMMEMORATIVE 1905
HMS FOUDROYANT & HMS VICTORY**



1905/4E

(-)

Diameter: unknown, loop suspension

Metal: Copper

Rarity: -

[1905/4E.3]

Issued throughout the Empire



Obverse: Inscr FROM / B.F.S.S. / NELSON CENTENARY / FOUDROYANT AND / VICTORY COPPER / E.R. VII. / (no bar below E.R.VII.; decorative elements flank FROM)

Reverse: Like 1905/1A

Versions: *1905/4E.1 Reserved*

1905/4E.2 Reserved

1905/4E.3 In elaborate diamond-shaped surround

WAIHI GOLD 1905



1905/5
(-)

Diameter: 34 mm, with loop suspension
Metal: Gold
Rarity: R7

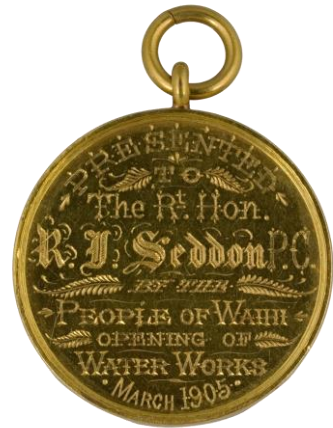

Obverse: View of mine facilities. Inscr around WAIHI GOLD MINING INDUSTRY . . * . .
Reverse: Engraved PRESENTED / TO / The Rt. Hon. / R.J. Seddon P.C. / BY THE / PEOPLE OF WAIHI / OPENING OF / WATER WORKS / . MARCH 1905 . Decorative fern leaves to left and right flanking short text lines
Note: Recorded as selling for NZ\$10,000 at auction in 2013 (see Mintmark no. 346)

Reproduced by kind permission of Te Papa. Image credit: Gold medal, 'Waihi Gold Mining Industry', 1905, New Zealand, maker unknown. Purchased 2013. CC BY-NC-ND 4.0. Te Papa (GH024119). <https://collections.tepapa.govt.nz/object/1360803>.

NEW ZEALAND VS. WALES 1905

The Match of the Century (Welsh: Gêm y Ganrif) is the unofficial name of a rugby union Test match played between Wales and New Zealand at Cardiff Arms Park on 16th December 1905 in front of a crowd of 47,000. The game was billed as the "Match of the Century" or "The World Championship" as it was a first meeting of the top two international teams.

The match was part of New Zealand's "Originals" tour and was their only loss in 35 matches. Final score was 3-0 from a try by Morgan in the 23 min. The result provoked much debate, with later writers noting its impact on the sporting culture of both countries. The Welsh crowd's singing of Hen Wlad Fy Nhadau as a response to the All Blacks' Haka is often cited as the first national anthem to be sung before an international sports event. (Source: Wikipedia)



1905/6

(-)

Diameter: 40 x 32 mm, with loop suspension
 Metal: Gold (15ct, hallmarked) + enamel
 Rarity: R6 (15 awarded, 6 currently known)



Images courtesy of Cardiff Rugby Museum

Obverse: In centre Prince of Wales' feathers, crossed leeks below. Surrounding elements from top: red dragon to L; ribbon (gold on red) inscr. WALES. V NEW ZEALAND; oval panel with Southern Cross to L of feathers, another with a fern to R; ribbon below feathers with inscr. CARDIFF. 1905 against pale blue background

Reverse: Plain with maker's mark LONG CARDIFF at top; at base hallmarks 15, 625, Birmingham Assay Office mark for July 1906-June 1907 and sponsor's mark M&B (Marples & Beasley, Birmingham jewellers)

Note: Gold medal presented to Rhys Gabe following Wales' victory over New Zealand at Cardiff on 16 December 1905. Item held by Cardiff Rugby Museum



1905/6A
(-)

Diameter: 43 x 28 mm, with loop suspension

Metal: Silver + enamel

Weight: 16 g

Rarity: R6

Images courtesy of New Zealand Rugby Museum (2005.319.1)



Obverse: Cardiff arms including mural crown and blue ribbon inscr VILLA CARDIFF below; another inscr NEW ZEALAND v. WALES crossing between crown and shield above. Below, a second shield with dragon to L, all in a wreath

Reverse: Engraved A MEMENTO FROM / THE LORD MAYOR / of the / CITY OF CARDIFF / ALDERMAN / ROBERT HUGHES JP / 1905 with maker's mark W.J.D. (William James Dingley, silversmith) and hallmarks (Birmingham 1905). Engraved design features: mural crown at top, scroll elements to sides and wreath below

1905/6B
(-)

[illustration unavailable]

Diameter: 38 x 25.4 mm
(oval shape)

Metal: Silver + enamel

Rarity: R7?

[illustration unavailable]

Obverse: Cardiff arms including mural crown and blue ribbon inscr VILLA CARDIFF below; another inscr NEW ZEALAND v. WALES above. All in wreath of fern leaves. At base, pale blue ribbon inscr DEC 26TH 1905

Reverse: Plain for engraving; reported as hallmarked Birmingham 1905

Note: Example sold by Mullocks Auctions in the UK in 2014 (sale 10 Dec 2014, lot 865), hammer price £400

DEVONPORT PARISH 50TH ANNIVERSARY 1906

1906/1



Diameter: 32 mm, pierced
Metal: Copper
Rarity: R6
Maker: Wright & Son,
Edgware,
Middlesex



Obverse: Inscr TO COMMEMORATE / THE 50TH YEAR OF THE / WORK OF THE CHURCH / IN THE PARISH OF / DEVONPORT. / AUCKLAND DIOCESE / N.Z.

Reverse: Inscr -.- / 18TH MAY – 1906 / HOLY TRINITY CHURCH / DEVONPORT / N.Z. / 1856 – 1906 / -.-

In minute letters at base WRIGHT - EDGWARE - ENGLAND

DEATH OF SEDDON 1906

Richard John ("King Dick") Seddon (1845-1906) was Premier of New Zealand from 1893 until his sudden death aboard ship while returning from a trip to Australia in June 1906.



1906/2

Diameter: 19.3 mm, pierced,
loop suspension
Metal: Silver, Aluminium,
Gilt
Rarity: R6, R4, R??



[1906/2.1]

Obverse: Inscr IN / MEMORIAM (curved) / BORN / 22ND JUNE . 1845 / DIED / 10TH JUNE / 1906.
Reverse: In centre circle Seddon facing ¾ right. Inscr around RIGHT HON. RICHARD JOHN SEDDON , P.C. LL. D. *
Note: Reverse design also used as obverse of M1906-07/3
Versions: 1906/2.1 Silver
1906/2.2 Aluminium
1906/2.3 Gilt



[1906/2.2]



[1906/2.3]



NEW ZEALAND INTERNATIONAL SHOW 1906

Held under the auspices of the Canterbury Agricultural And Pastoral Association.

Note: A separate event to the New Zealand International Exhibition 1906-07 (see M1906-07/1 ff.)



1906/3
(1906/1 in Supplement)

Diameter: 55 mm, pierced,
loop suspension
Metal: Silver, Aluminium
Rarity: R6, R4
Maker: G. Coates & Co.

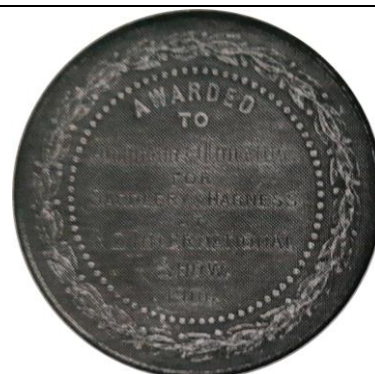

[1906/3.1]

Obverse: Wheat sheaf and plough; three circles above with heads of a cow, horse and sheep. In outer circle inscr around above CANTERBURY AGRICULTURAL AND PASTORAL ASSOCIATION and around below * FOUNDED 1863 *. In minute letters at base G COATES & CO CHRISTCHURCH

Reverse: In dotted circle inscr AWARDED / TO and engraved text below Johnson & Couzins / FOR / SADDLERY & HARNESS / AT / N Z. INTERNATIONAL / SHOW / 1906. Wreath of wheat ears in outer circle

Note: This medal is the normal Canterbury Award Medal. It was adapted for use at the annual show held in November 1906 at Christchurch A&P show grounds, Addington.

Varieties: 1906/3.1 Silver
1906/3.2 Aluminium

[illustration unavailable]

[1906/3.2]

[illustration unavailable]

EMPIRE DAY 1906

The statue of Sir John Logan Campbell (“the Father of Auckland”, 1817-1912) was unveiled at Cornwall Park on 24 May 1906 (Empire Day, created in 1903) by Lord Plunket (The Rt. Hon. Sir William Lee Plunket, KCMG KCVO KBE, 5th Baron Plunket, 1864-1920, Governor of NZ 1904-1910). Campbell was later buried under the 30 m obelisk on Maungakiekie (One Tree Hill).



1906/4
(-)

Diameter: 45 mm,
loop suspension
Metal: Silver
Rarity: R7
Maker: A. Teutenberg



Obverse: Stock die with North Head (Auckland) and Rangitoto Island between cabbage trees and ferns

Reverse: Stock die with shield in wreath. A. TEUTENBERG AUCKLAND N.Z. in small letters inside rim below (note D of AUCKLAND damaged and resembles an L). Shield engraved TO / Messrs Nobles & Hoare / TO / COMMEMORATE EXISTING / UNINTERRUPTED BUSINESS / RELATIONS EXISTING / FOR MORE THAN / HALF A CENTURY WITH / MESSRS. / BROWN CAMPBELL & CO. / THIS IS PRESENTED BY / THE NOW SOLE / PARTNER / Sir John Logan Campbell; engraved EMPIRE DAY 1906 inside top rim above shield

Note: This medal was the subject of an article in Mintmark #440, October 2021, placing it in the context of other items by Anton Teutenberg.

**DEATH OF SEDDON AND
NEW ZEALAND INTERNATIONAL EXHIBITION CHRISTCHURCH 1906-07**

1906-07/1



Diameter: 39 x 27 mm,
loop suspension,
crowned shield
shape

Metal: Gilt
Rarity: R4
Maker: Stokes
Issue price: 1/-



Obverse: In centre circle bust of Seddon facing $\frac{1}{2}$ R; in field at L PRE- / OF / 13; at R MIER / N.Z. / YRS. Inscr around above R.J. SEDDON, FOUNDER & PRES. OF N.Z. EXHN. and around below DIED JUNE 10 / 1906

Reverse: Exhibition building. 1906 . 7 above; N. Z. I. EXHIBITION / CHRISTCHURCH in exergue

Note: Medal blanks same as for 1902/12-17 (obverse as per Reverses C-E; reverse as per standard obverse for that series)

1906-07/2



Diameter: Various sizes
reported between
18/20 and 35 mm
(2 examples
illustrated)

Metal: Bronze
Rarity: R6 (at least 4
observed by
present authors
so downgraded
from previous R7)



Obverse: Bust of Seddon $\frac{1}{2}$ R

Reverse: Blank

Note: Undated but included here because of commonality with other Seddon medals



[diameter unknown]



NEW ZEALAND INTERNATIONAL EXHIBITION CHRISTCHURCH 1906-07

This impressive exhibition was opened on 1 November 1906 in North Hagley Park, with buildings spread over some 14 acres. The most outstanding building was the Main Building which is featured on medallions. The Government assumed financial responsibility and was required to pay £81,430 to cover the loss incurred. By the closing date 1,967,632 persons had visited the exhibition, but only 938,621 were paying visitors. Many nations from Europe, the Pacific and Empire and the United States contributed exhibits. As recorded under M1906-07/1, the originator and founder Premier Seddon died prior to the opening.

1906-07/3



Diameter: 19.3 mm
 Metal: Silver, Aluminium,
 Bronze (or
 Copper-Gilt)
 Rarity: R7, R6, R6



[1906-07/3.1]

Sutherland # 448

Obverse: In centre circle Seddon ½ R. Inscr around RIGHT HON. RICHARD JOHN SEDDON P.C., LL.D. *

Reverse: Open wreath in centre; inscr EXHIBITION SOUVENIR around above

Note: Possibly a mule of M1906/2 and M1904/2, 4 or 5

Versions: 1906-07/3.1 Silver (loop suspension, broken off in illustrated example)
 1906-07/3.2 Aluminium (pierced)
 1906-07/3.3 Bronze or copper-gilt (pierced)



[1906-07/3.2]



[1906-07/3.3]





1906-07/4



Diameter: 33 mm, 6 pointed
Stamped out star with cut-outs

Metal: Aluminium

Rarity: R6

Obverse: In centre of “hub” 1906/’07. Inscr around above CHRISTCHURCH and around below * N.Z. *

Reverse: Blank

Note: The “blank” on which 1906-07/5 and 1906/07/5A were struck. The late Malcolm Johnson’s website <https://sites.google.com/site/malsprojects/metal-typer> contained details of the “Metal-Typer” device used to produce these and many other related products, but this now seems to have been taken down (July 2023)



1906-07/5



Diameter: 33 mm, 6 pointed
Stamped out star with cut-outs

Metal: Aluminium

Rarity: R3 for type (c. 150 different inscriptions known to date; individual inscriptions unique)

Obverse: Like 1906-07/4, with personalised inscription machine-stamped in outer circle

Reverse: Blank

Note: For a payment, visitors to the Exhibition could use a machine which stamped letters around the rim. These do not appear to have been pierced for suspension when made, but examples with presumably subsequent piercings are known. See also note to 1906-07/4

See following table for list of known names stamped on the medal

Please email martin_lists@yahoo.com with details of others for our records

Commemorative Medals – 1900s

A FIELDER . 14 BRISTOL ST . CH CH
 A R INSTONE 107 CHESTER ST (Christchurch)
 A READ. HEREFORD ST. LINWOOD
 A WALLACE GRAFTON RD . AUCKLAND
 A. BURNS 6 EDEN ST DUNEDIN
 ADA PEARL HERRICK
 ALEX .A.ROSENBLUM SIMPSON ST
 ALFRED PENNY SANSON
 ALICE P BRAME BALCLUTHA DEC 17 (1906)
 ALICE TATUMS MASCOTT 16 2 07
 ANDREW MCPHERSON STUDHOLME
 ANGUS MACDONALD INVERCARGILL
 ARTHUR THOMAS LIVERMORE NOV .I.
 AUBREY BISS NEWTOWN WELLINGTON
 B. JONES WANGANUI D.H.S.
 B.T.IMPERLEY WAIROA H.B.
 BOB LYALL. HUNTERVILLE. N.Z.
 C. BOOKER 141 PETERBOROUGH ST (Christchurch)
 CHARLIE BANNIN, CARTERTON
 CLARA BRADER WASHDYKE N Z
 CLARA RODDA HUMBER ST OAMARU
 DICK HARRISON PORT CHALMERS
 DORIS CHISNALL STOKE NELSON
 DORIS HODDINOTT SYDENHAM.
 DOUGLAS INGLIS. CHRISTCHURCH
 E TALLOTT. N Z EXHIBITION
 E. DANIELS . MOUNT EDEN . AUCKLAND
 E. HILL BRIGHTWATER NELSON
 E. SKINNER
 EDWARD CLARK NEW PLYMOUTH
 EDWARD GOURLAY LINWOOD
 EDWARD KNOWLES CAMERON MATAWHERO
 ELIZABETH THOMSON DUNEDIN, DEC.5 (1906)
 ELSIE B MCCULLOCH ROSLYN DU (nedin)
 EMILY F. WALKER. WHANGAREI
 ERMA HOWE. NZ EXHIBITION
 ESTELLE DAVIS CHRISTCHURCH
 ETHEL WHITEHEAD. AUCKLAND
 EXHIBITION F. HUDSON PAPANUI
 F A TEAGUE DURHAM ST SYDENHAM
 F J SUMMERFIELD . 18 HEREFORD ST
 FRANK VALE FROM N.Z.I.E.
 FRED ADMORE DUNEDIN N Z
 FROGED FACED FIRDRDINAND
 G.B.SHAW NOV.30 1906
 G.CLUTTER BUCK. GEELONG
 GEL CAMPBELL BIBLE BANGER
 GEORGE CHRISTIANSEN MARCH 26.06 (wrong yr)
 GEORGE DUNS SUMNER NOV 7.
 GEORGE TRILLO N.Z.R. WELLINGTON
 GLADYS BUDDLE FEB.2 07
 GLADYS STEWART PALMERSTON
 H A ROUT EXHIBITION 1906
 H R ISLAND BLOCK OTAGO
 H . V. BARFORD WAIMATE JAN 10 (1907)
 H . W. KIRKWOOD . NELSON . NZ.
 H.GLYNN OAMARU
 H.MARTINDALE
 HAROLD VALE FROM N.Z.I.E.
 HARRY VALE FROM N.Z.I.E.
 HARRY LANGE.ROSELEATH. WGTM
 HERBERT LONGDON DURHAM ST CH
 HILDA MEYER 40 TARANAKI ST.
 J FRANCE . MILTON . OTAGO . N . Z .
 J. BAIRD N.Z. EXHIBITION
 J. DAVIDSON MORNINGTON MAR.27.07
 J. JAMIESON . NAPIER . N.Z.
 J. SUMMERFIELD 18 HEREFORD ST
 J.G.BARKER. 186 COLOMBO ST.CH CH
 J.J.CALLAVER 22 VIRG AVE AUCKLAND
 J.SHANNON WOODEND
 JACK ALDRIDGE EXHIBITION
 JACK HORRELL HORRELLVILLE
 JACK STEWART PALMERSTON
 JAMES E HAMPTON
 JAMES MASON ASHBURTON DEC 15
 JAN. 24 LOUIS SEEHOF INVERCARGILL
 JOE SUTTCLIFFE MARTON DEC. 28. 06
 JOHN JACKSON MILLERTON
 JOHN STREETER ADDINGTON
 JOHN W. REYNOLDS HILLGROVE
 KENNETH BAILEY RICcarton
 L. LEADBEATER PETONE N.Z.
 L.R.WILKINSON CH CH NOV 21
 LESLIE BAILEY . RICcarton .
 LILIAN MOONEY NOV.17 06
 LOIS CODY PATEA FEB . 28 .
 LOUISE EMILY PERREAU EXHIBITION
 LUDOVICA WALLER.EXHIBITION.
 M A WIER ISLAND BLOCK OTAGO
 M. A. HESSE RIFVER RD.RICHMD
 MAGGIE PARKIN SOUTHBROOK

Commemorative Medals – 1900s

MARY SLATTERLY WELLINGTON	REGINALD CHRISTIANSEN MARCH 26. 06 (wrong yr)
MARY STEPHENS JAN 7 GREYMOUTH	REGINALD DOYLE SOUTH LOBURN
MATHEW HODGEN PREBBLETON .	ROBERT GREATHAM CHATFIELD
MAY LUMMIS RICCARTON	ROSLYN DU ELSIE L McCULLOUGH
MEET ME ON THE PIKE	ROY MCNICHOLL . LEES ST. DUNEDIN
MERRON PATTERSON ASCOT VALE	RUBIN REEVES.HALL ST ST MASTERTON
MILDA FAMA WELLINGTON 1907	RUBY BELL NOV 10
MINNIE DICKIE TE MATAI	SIR KGT F. BURNNARD R.B.P. 149
MOIR CRADDOCK SIMES NOV. 9	STANELY G, MATHIAS B.N.S.W.
MRS ILLINGWORTH DUNEDIN FEB. 13	STAR REHU TEMUKA FEB. 20
MRS JAS BROWN . WELLINGTON	T & E DAVENPORT LINWOOD
MUIR A.E.KITCHENER CAMP DRIVER	T . MILLER . WELLINGTON
MURIEL BRABAZON. 8 MADRAS ST.	T PORTERFIELD. ISLINGTON, N.Z 1906
MYRTLE BAILEY TEMPLETON	TEDDY GOURLAY LINWOOD.CH CH
N.S.LUNN KOEKE EXHIBITION	THOMAS ARTHUR POTTER LISTER
N FINCH WAKAKAHI WAIMATE	V. BARTOSH HAWKES BAY.
NELLIE DRAKE PORT CHALMERS	VAL FULFORD WALTHAMS— W
NELLIE WARMINGTON WELLINGTON	VALERIE LLOYD N.Z.I.E.
NELLIE WELLS . KAIAPOI	VERA RICHARDS.LEVIN.WELLINGTON
O HARDING DUNEDIN N Z	W . H . PARKINSON WAIMATE NOV. 1
ONSLOW PETHERICK HUNTERVILLE	W.F. BALDWIN EXHIBITION
P.N.C. BRUISER	W.H.PARKINSON WAIMATE NOV 1
PNS WHILLER ...	W.J. BUCKLEY. LEWISHAM
PEARLE WILSON WOOLSTON DEC. 11	W.R.STEPHENS.SYDENHAM. CH CH
PEGGY HUNT QUINTETTE FEB 27	W. ELMS ...
PERCEVAL H . ADAMS WESTPORT.	W. LEGG. AUSTIN ST. WN
PERLE BAILEY 127 HARPER ST CHRISTCHURCH	W. SUTERS MORNINGTON.
PETE PURVES CH CH N.Z.E.I.	WALTER KENT . MILTON. 19.3.07.
PETER J ANDERSON PORT CHALMERS	WILLIAM BARKER BLUFF 1906
PLANET CYCLES FEATHERSTON	WILLIAMSTOWN FOOTBALL CLUB 08
R B C PASTIME O Y C CH CH EXH	WILLIE GOURLAY LINWOOD CH.CH
R E CARRINGTON BELFAST (Christchurch)	WINNIEFRED EVANS MT. EDEN RD.
R. E. BOOKER 141 PETERBOROUGH (Christchurch)	

1906-07/5A



Diameter: 33 mm, 6 pointed
Stamped out star
with cut-outs
Metal: Aluminium
Rarity: R6 for type,
individual
inscriptions
unique



Obverse: Like 1906-07/5 but the blank was inserted in the stamping machine upside down which resulted in the name being struck on reverse
Reverse: Centre blank; name etc. in outer circle
Note: For a payment, visitors to the Exhibition could use a machine which stamped letters around the rim. These do not appear to have been pierced for suspension when made, but examples with presumably subsequent piercings are known. See also note to 1906-07/4

See following table for list of known names stamped on the medal

Please email martin_lists@yahoo.com with details of others for our records

A. MC . DONALD . TERMINUS.

C.P. WORLEY NELSON N.Z.

JOHN STEVENSON CLYDEVALE OTAGO

R. JOHNSON S.S. ARDOVA

RUBY.STRINGER.ROWE.ST.BALLARAT

W.J.G. MATHEWS. BALLARAT E. 1908

1906-07/6, 6A (7), 8, 8A (9-10) have been moved to the Undated section as they appear with later stamped dates and may have had no connection with the NZI Exhibition. These numbers have been retired.

1906-07/11



Diameter: 22.5 x 22.5 mm,
loop suspension,
cross shaped
Metal: Silver, Gilt, Brass
Rarity: R4
Maker: Stokes
Issue price: 2/- (silver), 1/-



[1906-07/11.1]

Obverse: Exhibition building in centre circle. In lobes, clockwise from left: N . Z . I . / EXHIBN / C'CHURCH / 1906 . 7

Reverse: Kiwi to L in centre circle, with plant life extending into L and R lobes. In lobes, clockwise from left: KIAORA - SOUVENIR / OF / N . Z. - HAEREMAI - 1906 . 7

Versions: 1906-07/11.1 Silver
1906-07/11.2 Gilt
1906-07/11.3 Brass



[1906-07/11.2]



[1906-07/11.3]



1906-07/11A

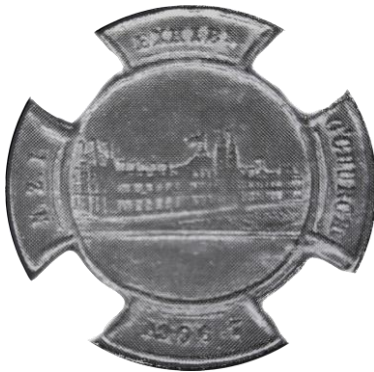

Diameter: 44.5 x 17 mm at loop, loop suspension, suspension bar, cross shaped

Metal: Gilt (medal + suspension)

Rarity: R6



Obverse: Like 1906-07/11
 Reverse: Like 1906-07/11
 Note: Suspender bar inscr SOUV ENIR divided by a circle with script NZ inside

1906-07/12



Diameter: 40.5 mm, with double loop suspension and 40 mm suspender

Metal: Gilt brass

Rarity: R5

Maker: Schwaab Stamp & Seal Co.



Obverse: In centre circle Exhibition building with boats on Avon in foreground. Inscr around above INTERNATIONAL / EXHIBITION in curved lines and CHRISTCHURCH curved below. Dates 1906 and 1907 in rectangles to L and R. NEW ZEALAND in rectangle above. The whole in a floral/diamond-shaped surround

Reverse: Blank with maker's stamp SCHWAAB S & S. / CO. / MILWAUKEE

Note: SOUVENIR on suspender bar

1906-07/13



Diameter: 20.5 mm, pierced

Metal: Gilt

Rarity: R4

An eagle, wings outspread, holding bundle of arrows in talons on stick pin attached to medallion



Obverse: Exhibition building in centre; inscr NEW ZEALAND / INTERNAT'L curved above; EXHIBITION curved below

Reverse: Inscr in curved lines CHRISTCHURCH / [decorative element] / 1906 – 1907

1906-07/14



Diameter: 19 mm, loop suspension, unpierced, pierced
 Metal: Silver, Gilt, Copper
 Rarity: All R6



[1906-07-14.1]

Obverse: In centre 1906-7 between ornamental semicircles above and below; inscr N.Z. INTERNATIONAL / * EXHIBITION * curved above; . CHRISTCHURCH . curved below

Reverse: Exhibition Building

Note: Link with straight bar ribbon clasp noted

Versions: 1906-07/14.1 Silver (loop suspension)
 1906-07/14.2 Gilt (unpierced)
 1906-07/14.3 Copper (pierced)



[1906-07-14.2]



[1906-07-14.3]





1906-07/15

Diameter: 36 mm, milled edge
 Metal: Gilt, Brass
 Rarity: R5, R5



[1906-07/15.1]

Obverse: Exhibition building with boats on Avon in foreground. Inscr around above NEW ZEALAND INTERNATIONAL / EXHIBITION and around below 1906-1907 / CHRISTCHURCH

Reverse: Conjoined crowned effigies of Edward VII and Alexandra to R. Inscr around above KING EDWARD VII QUEEN ALEXANDRA

Versions: 1906-07/15.1 Gilt (pierced)
 1906-07/15.2 Brass (unpierced)



[1906-07/15.2]





1906-07/16

Diameter: 28 mm, loop suspension and suspender bar

Metal: Gilt, Copper

Rarity: R4, R4

[1906-07/16.1]



Obverse: Exhibition building with boats on Avon in foreground. Inscr around above INTERNATIONAL EXHIBITION / NEW ZEALAND and around below 1906-1907 / CHRISTCHURCH

Reverse: Edward VII ½ facing L. KING EDWARD VII around below

Note: Loop suspension with link to bar on which in ornate frame SOUVENIR

Versions: 1906-07/16.1 Gilt
1906-07/16.2 Copper



[1906-07/16.2]





1906-07/17

Diameter: 31.5 x 22.7 mm, heart shape, loop suspension

Metal: Gilt

Rarity: R5

Maker: Schwaab Stamp & Seal Co.







Obverse: Exhibition building. Inscr NEW ZEALAND / INTERNATIONAL / EXHIBITION above; CHRISTCHURCH / 1906 – 1907 below (dates framed in decorative outline)

Reverse: Blank with maker's mark SCHWAAB S. & S. CO / MILWAUKEE

Note: Loop suspension with link to bar on which in ornate frame SOUVENIR, like 1906-07/16. See also 1908/7

Commemorative Medals – 1900s

	<p style="text-align: center;">1906-07/18</p> <p>Diameter: 32.5 mm, milled edge, pierced & unpierced</p> <p>Metal: Aluminium</p> <p>Rarity: R4</p>	
<p>Obverse: Inscr NEW ZEALAND EXHIBITION / -.- / CHRISTCHURCH / 1906-7</p> <p>Reverse: Exhibition Building</p>		

	<p style="text-align: center;">1906-07/18A (1906-07/19)</p> <p>Diameter: 32 mm</p> <p>Metal: Aluminium</p> <p>Rarity: R4</p>	
<p>Obverse: Cockerel to R; inscr around above DEFIANCE BUTTER and on ribbon below BEATS THEM ALL</p> <p>Reverse: Like 1906-07/18</p> <p>Reference: Also Gottermeyer N2a in John Bertrand listing of special-purpose tokens. Cf M1904/8 (G#N2) for a related obverse design</p>		

Note: No. 1906-07/19 has been retired.

1906-07/20



Diameter: 22.5 mm
 Metal: Silver, Gilt
 Rarity: R6, R5
 Maker: Stokes
 Issue price: 2/- (silver); 1/-



[1906-07/20.1]

Obverse: Central section of Exhibition building (dome and towers) with flags flying to left. N . Z . I . EXHIBITION 1906 . 7 around above, CHRISTCHURCH in exergue. Circle of dots inside rim; left flag points between I. and E

Reverse: Bust of Seddon ½ R. Inscr around above R. SEDDON , FOUNDER & 1ST . PRES . OF N.Z. EXH^N

Versions: 1906-07/20.1 Silver (pierced)
 1906-07/20.2 Gilt (unpierced)



[1906-07/20.2]



Commemorative Medals – 1900s



1906-07/20A
(1906-07/22)

Diameter: 22.5 mm, pierced
Metal: Silver, Gilt
Rarity: R5, R5

[1906-07/20A.1]



Obverse: Similar to 1906-07/20
Reverse: Like 1898-99/7
Versions: 1906-07/20A.1 Silver
 1906-07/20A.2 Gilt



[1906-07/20A.2]





1906-07/20B
(1906-07/23)

Diameter: 22.5 mm, pierced
& unpierced
Metal: Silver, Gilt, Brass,
Copper
Rarity: R5, R3, R4, R4



[1906-07-20B.1]

Obverse: Like 1906-07/20

Reverse: Head and shoulders of Māori man in cloak to L. Inscr around above HAEREMAI E NGA IWI O TE AO [Welcome to the peoples of the world]. Thin line under legends broken by top of head

Versions: 1906-07/20B.1 Silver
1906-07/20B.2.1 Gilt, pierced
1906-07/20B.2.2 Gilt, unpierced
1906-07/20B.3 Brass
1906-07/20B.4 Copper



[1906-07-20B.2.1]



[illustration unavailable]

[1906-07-20B.2.2]

[illustration unavailable]



[1906-07-20B.3]



Commemorative Medals – 1900s

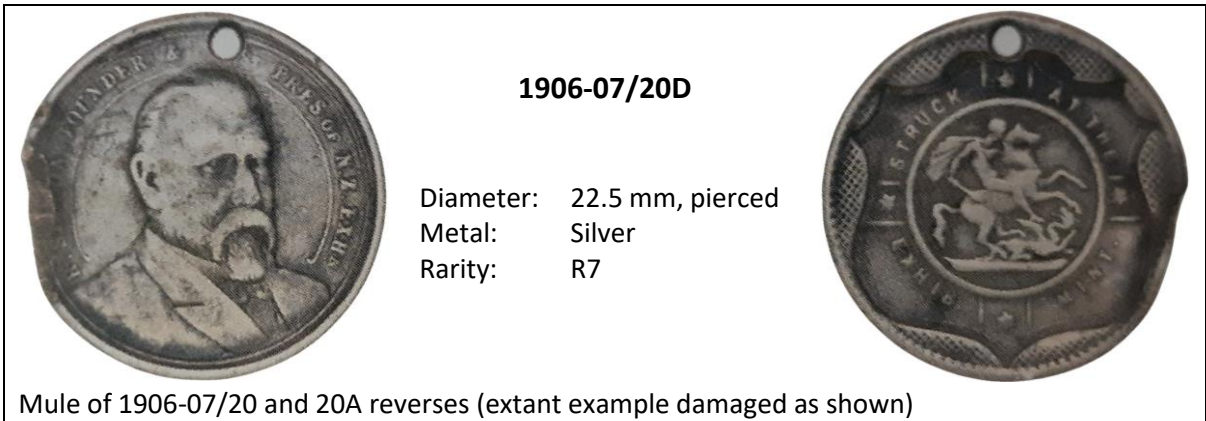
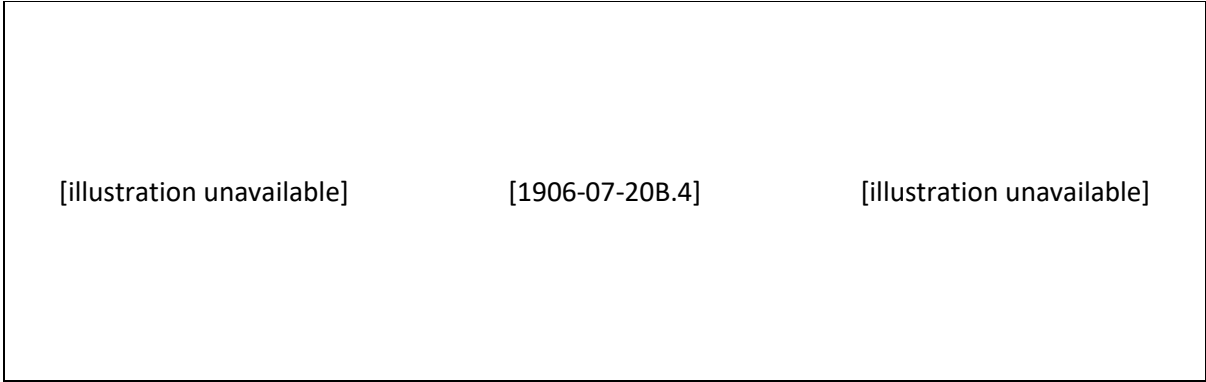

1906-07/21



Diameter: 22.5 mm, pierced
 Metal: Silver, Gilt,
 Copper
 Rarity: All R4



[1906-07/21.1]

Obverse: Like 1906-07/20 but left flagpole points to E, CHRISTCHURCH curved, no dotted inner border, no flags to L and R of main towers

Reverse: Like 1906-07/20

Versions: 1906-07/21.1 Silver
 1906-07/21.2 Gilt
 1906-07/21.3 Copper



[1906-07/21.2]



[1906-07/21.3]



1906-07/25

[illustration unavailable]

Diameter: 30.75 mm,
pierced
Metal: Silver, Gilt, Brass
Rarity: -, R4, R4
Maker: Stokes
Issue price: 3/- reported for
silver; 1/-

[illustration unavailable]

[1906-07/25.1]

Obverse: Perspective view of Exhibition building with 7 flags. Inscr around above N.Z. EXHIBITION and in exergue 1906 . 7 / CHRISTCHURCH

Reverse: In inner circle, bust of Māori man in cloak to L as on 1906-07-20B. Inscr around above HAEREMAI E NGA IWI O TE AO. In outer circle inscr COMMEMORATION MEDAL N . Z . I . EXHIBITION 1906 . 7 .

Versions: 1906-07/25.1 Silver (reported but unconfirmed)
1906-07/25.2 Gilt
1906-07/25.3 Brass (Note illustrated example appears to have an extra dot before the N of N.Z.I.)



[1906-07/25.2]



[1906-07/25.3]



Note: Nos. 1906-07/22-24 have been retired.

Commemorative Medals – 1900s



1906-07/25A
(1906-07/26)

Diameter: 30.75 mm,
pierced &
unpierced
Metal: Silver, Gilt,
Copper
Rarity: All R4



[1906-07/25A.1]

Obverse: Like 1906-07/25 but 8 flags

Reverse: In inner circle, bust of Māori man in cloak to R. Inscr around above KIAORA & HAEREMAI [Hello and welcome]. In outer circle inscr around above COMMEMORATION MEDAL N . Z . I . EXHIBITION and around below 1906 . 7 .

Versions: 1906-07/25A.1 Silver
1906-07/25A.2 Gilt
1906-07/25A.3 Copper



[1906-07/25A.2]





[illustration unavailable]

[1906-07/25A.3]

[illustration unavailable]

Note: No. 1906-07/26 has been retired.

	1906-07/27	
		Diameter: 16.7 mm, loop suspension (see Note)
		Metal: Aluminium
		Rarity: R6
Obverse:	Wider perspective view of Exhibition building with square flag on dome. Inscr around above N.Z. EXHIBITION and in exergue 1906 . 7 / CHRISTCHURCH	
Reverse:	Dotted circle with plain centre for engraving. Inscr around above SOUVENIR and below GOOD LUCK. Floral elements at sides separate top and bottom text	
Note:	Illustrated example may have had its suspension loop broken off and the piercing added later	



1906-07/27A
(1906-07/28)

Diameter: 16.9 mm, loop suspension
 Metal: Gold, Gilt, Aluminium
 Rarity: R7, R4, R3, R4, R5
 Maker: Stokes



[1906-07/27A.1]

Obverse: Like 1906-07/27; note square flag in centre (cf different flag on 1906-07/32)
 Reverse: Kiwi to L. Inscr around above KIAORA & HAEREMAI with curved line below. Inscr KIWI curved in exergue
 Versions: 1906-07/27A.1 Gold
 1906-07/27A.2 Gilt
 1906-07/27A.3 Aluminium



[1906-07/27A.2]



[illustration unavailable]

[1906-07/27A.3]

[illustration unavailable]

Note: Nos. 1906-07/28-29 have been retired.



1906-07/27B
(1906-07/29)



Diameter: 17 mm, loop suspension
Metal: Gilt, Bronze
Rarity: R6

[1906-07/27B.1]

Obverse: Like 1906-07/27
Reverse: St George & Dragon in centre circle, based on Pistrucci design. In outer circle inscr around STRUCK AT THE EXHIBITION MINT .

Versions: 1906-07/27B.1 Gilt
 1906-07/27B.2 Bronze



[1906-07/27B.2]





1906-07/27C
(1906-07/31)



Diameter: 17 mm, loop suspension
Metal: Gilt
Rarity: R6

Obverse: Like 1906-07/27
Reverse: Edward VII, bust ½ L; inscr around STRUCK AT THE EXHIBITION MINT . . .

Commemorative Medals – 1900s



1906-07/27D
(1906-07/54)

Diameter: 17 mm
Metal: Silver
Rarity: R6

[1906-07/27D.1]



Obverse: Like 1906-07/27
Reverse: Blank, sometimes with personal engraving
Versions: 1906-07/27D.1 Silver with loop
 1906-07/27D.2 No loop, on cufflink with attachment



[1906-07/27D.2]







1906-07/30
(1906-07/55)

Diameter: 17 mm
Metal: Gilt
Rarity: R6



Obverse: Like reverse of 1906-07/27A
Reverse: Like 1906-07/27B

Commemorative Medals – 1900s

	<p>1906-07/30A (1906-07/37)</p> <p>Diameter: 16.5 mm, loop suspension Metal: Gilt Rarity: R5</p>	
<p>Obverse: Like 1906-07/30 Reverse: Like 1906-07/27C</p>		

	<p>1906-07/30B (1906-07/30)</p> <p>Diameter: 17 mm, loop suspension Metal: Silver Rarity: R6</p>	
<p>Obverse: Like 1906-07/30 Reverse: Blank</p>		

1906-07/32

[illustration unavailable]

Diameter: 17 mm, loop
suspension
Metal: Gold, Silver, Gilt
Rarity: R6, R4, R4
Issue price: -, 1/6 (Ag), 1/-

[illustration unavailable]

[1906-07/32.1]

Obverse: Like 1906-07/27 but dome flag has two tails

Reverse: Like 1906-07/27A

Versions: 1906-07/32.1 Gold
1906-07/32.2 Silver
1906-07/32.3 Gilt
1906-07-32.4 Bronze



[1906-07/32.2]



[1906-07/32.3]



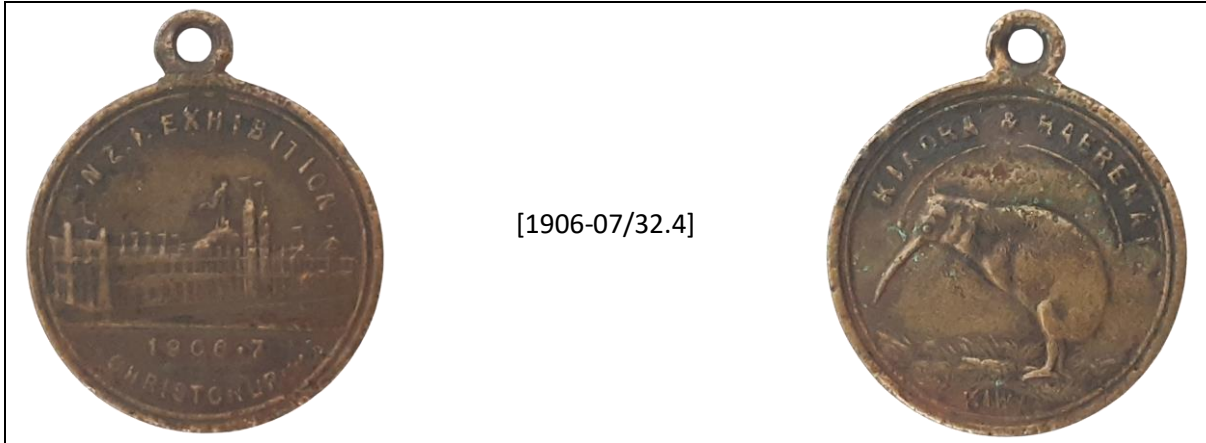

Commemorative Medals – 1900s



[1906-07/32.4]

Note: No. 1906-07/31 has been retired.

	<p>1906-07/32A (1906-07/35)</p>	
	<p>Diameter: 17 mm Metal: Gilt, Aluminium Rarity: R6</p>	
	<p>[1906-07/32A.1]</p>	
<p>Obverse: Like 1906-07/32 Reverse: Like 1906-07/27B Versions: 1906-07/32A.1 Gilt 1906-07/32A.2 Aluminium</p>		
<p>[illustration unavailable]</p>	<p>[1906-07/32A.2]</p>	<p>[illustration unavailable]</p>



	<p>1906-07/32B (1906-07/33)</p>	
	<p>Diameter: 17 mm, pierced & unpierced Metal: Copper gilt, Aluminium Rarity: R6</p>	
	<p>[1906-07/32B.1]</p>	
<p>Obverse: Like 1906-07/32 Reverse: Like 1906-07/27C Versions: 1906-07/32B.1 1906-07/32B.2</p>	<p>Copper Gilt Aluminium</p>	
<p>[illustration unavailable]</p>	<p>[1906-07/32B.2]</p>	<p>[illustration unavailable]</p>

	<p>1906-07/32C (1906-07/34)</p>	<p>[illustration unavailable]</p>
	<p>Diameter: 17 mm Metal: Aluminium Rarity: R6</p>	
<p>Obverse: Like 1906-07/32 Reverse: Blank Note: Often found with name or initial engraved</p>		



Commemorative Medals – 1900s

	<p>1906-07/32D (1906-07/36)</p> <p>Diameter: 16.5 mm, loop suspension, pierced</p> <p>Metal: Aluminium</p> <p>Rarity: R6</p> <p>[1906-07/32D.1]</p>	
<p>Obverse: Like 1906-07/32</p> <p>Reverse: Like 1906-07/27</p> <p>Versions: 1906-07/32D.1 Loop suspension 1906-07/32D.1 Pierced</p>	<p>[illustration unavailable] [1906-07-32D.2] [illustration unavailable]</p>	

Note: Nos. 1906-07/33-37 have been retired.

	<p>1906-07/38</p> <p>Diameter: 17 mm, loop suspension</p> <p>Metal: Silvered</p> <p>Rarity: R6</p>	
<p>Obverse: Like reverse of 1906-07/27C</p> <p>Reverse: Like 1906-07/27B</p>		

1906-07/39



Diameter: 16 mm, loop suspension
Metal: Silver
Rarity: R7

Obverse: Central section of Exhibition building; inscr around above INTERNATIONAL / CH CH N.Z. and below 1906-7 / EXHIBITION
Reverse: Blank

1906-07/39A
(1906-07/52)



Diameter: ?? mm
Metal: Brass
Rarity: R6

Obverse: Details in centre circle like 1906-07/39 (Exhibition building; inscr around above INTERNATIONAL / CH.CH N.Z. and below 1906-7 / EXHIBITION), the whole between two crossed fern fronds
Reverse: Blank
Note: The central element appears to have been struck using the same die as 1906-07/39 (note size of 9 and raised letters NAL compared to rest of word)

1906-07/40

[illustration unavailable]

Diameter: 30 mm
 Metal: Gold, Silver Gilt,
 Silver, Bronze
 Rarity: R5, R6, R5, R6

[illustration unavailable]

[1906-07/40.1]

Obverse: In centre circle central section of Exhibition building (dome and two towers) with 1906 . 7 in exergue; in outer circle inscr around above NEW . ZEALAND . INTERNATIONAL . EXHIBITION and around below . CHRISTCHURCH . Left flagpole points to left leg of N, roofline at right points between I and O

Reverse: In dotted circle AWARDED / – TO – and blank field for engraving below; inscr around above HOME [lozenge] INDUSTRIES and around below SECTION between lozenges

Versions: 1906-07/40.1 Gold, 1.5 mm thick
 1906-07/40.2 Silver Gilt (dia. 31 mm reported)
 1906-07/40.3 Silver, 2 mm thick
 1906-07/40.4 Bronze, 2 mm thick



[1906-07/40.2]



[1906-07/40.3]



Commemorative Medals – 1900s

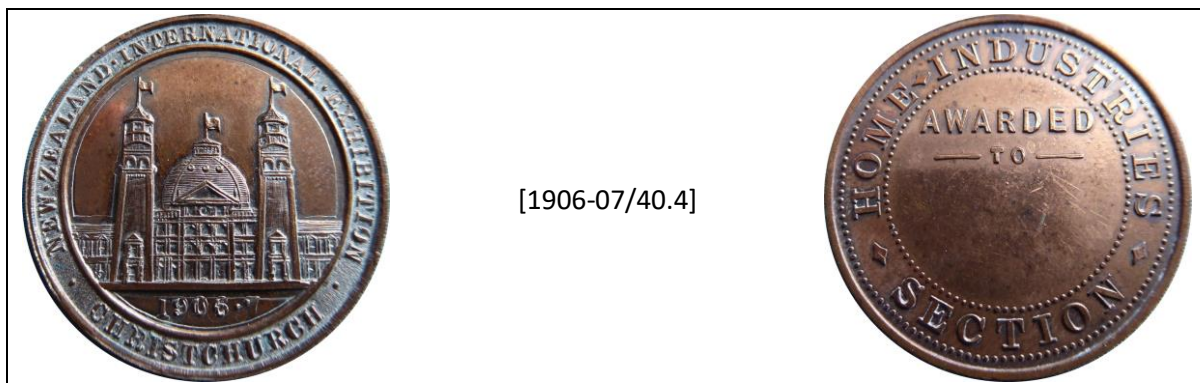

[1906-07/40.4]

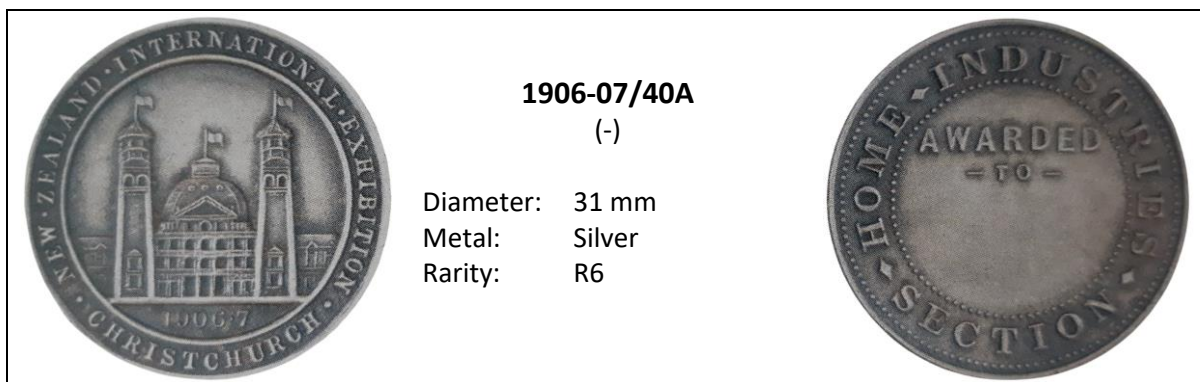

1906-07/40A

(-)

Diameter: 31 mm
Metal: Silver
Rarity: R6

Obverse: Like 1906-07/40 but die variety: roof line at right points between T and I

Reverse: Like 1906-07/40 but die variety: shorter dashes flanking TO

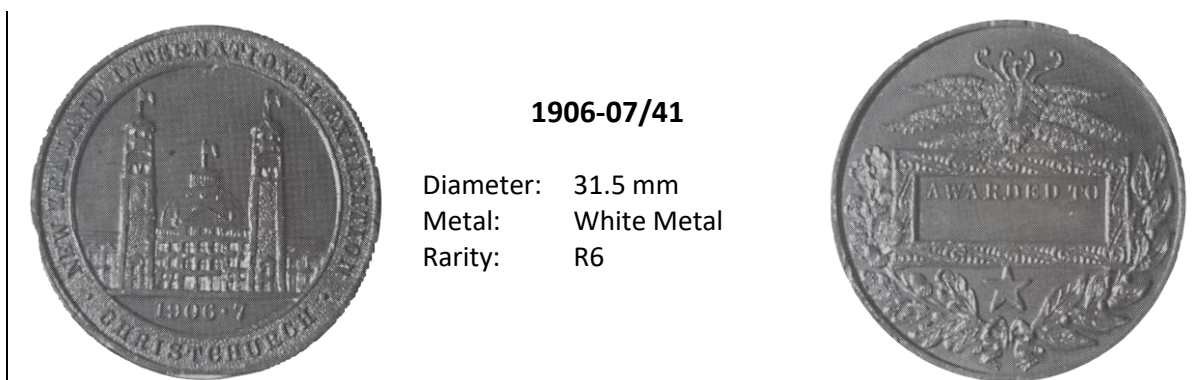

1906-07/41

Diameter: 31.5 mm
Metal: White Metal
Rarity: R6

Obverse: Like 1906-07/40 but rough surface to towers and rim band, stops only before and after . CHRISTCHURCH; left flag to centre of N; 1 of date between R and I

Reverse: Like 1906-07/44

Commemorative Medals – 1900s



1906-07/41A
(1906-07/42)

Diameter: 31.5 mm,
3 mm thick
Metal: Gilt
Rarity: R6



Obverse: Like 1906-07/41

Reverse: Blank (possibly a push pin fitting for a lapel badge)

Note: No. 1906-07/42 has been retired.



1906-07/43

Diameter: 40 mm
Metal: Silver, White
metal
Rarity: R6

[1906-07/43.1]



Obverse: Like 1906-07/40 but larger font in legends. Right roofline to T

Reverse: Like 1906-07/41 but first acorn touches frame

Versions: 1906-07/43.1 Silver
1906-07/43.2 White metal

[illustration unavailable]

[1906-07/43.2]

[illustration unavailable]



1906-07/44

Diameter: 31 mm
 Metal: Gold, Gilt
 Rarity: R6, R5

[1906-07/44.1]



Obverse: Like 1906-07/40 but left flag points to right leg of N, roofline at right to l
 Reverse: Rectangular panel with inscr AWARDED TO and space for engraving; panel framed by Māori koru pattern (4 full curls above and below). Leaf pattern above, star below, the whole in wreath. 1 of date between l and S
 Versions: 1906-07/44.1 Gold (18ct and 9ct reported)
 1906-07/44.2 Gilt



[1906-07/44.2]



1906-07/44A

(-)

Diameter: 31.5 mm
 Metal: Gilt
 Rarity: R6



Obverse: Like 1906-07/44 but rough surface to towers and rim band, stops only before and after . CHRISTCHURCH; left flag to left leg of N
 Reverse: Similar to 1906-07/44 but floral element at top closer to rim, star below panel offset slightly to L

Commemorative Medals – 1900s

1906-07/45



Diameter: 23 mm, pierced
 Metal: Gilt, Brass
 Rarity: R5
 Maker: Bridgland & King,
 Melbourne



[1906-07/45.1]

Obverse: Like 1906-07/40 but towers have saucer shape balcony; left flag between D and I
 Reverse: Like 1906-07/41 but inscription in frame in two lines reads AWARDED TO / H. PERRY & CO, in minute letters B & K MEL.
 Versions: 1906-07/45.1 Gilt
 1906-07/45.2 Brass



[1906-07/45.2]



1906-07/45A
(1906-07/46)



Diameter: 23 mm, pierced
 Metal: Brass
 Rarity: R5



Obverse: Like 1906-07/45 but variation, one window only in left annexe. plain field; left flag to I
 Reverse: Like 1906-07/45 but top ferns less bulky

Note: No. 1906-07/46 has been retired.

1906-07/47



Diameter: 30 mm
 Metal: White Metal
 Rarity: R7



Obverse: Inscr in wreath 1906.7 / NEW ZEALAND / INTERNATIONAL / EXHIBITION. / -.- / MINES DEPARTMENT, with blank space below for engraving; wreath open to top right

Reverse: Mine structure, fern curved behind. In field to R ESSAY / ON / MINING.

1906-07/48



Diameter: 23 x 18 mm,
 heart shaped,
 loop suspension
 Metal: Brass
 Rarity: R6



[1906-07/48.1]

Obverse: Stylised Exhibition building; inscr around above INTERNATIONAL / N.Z and around below EXHIBITION / 1906.7

Reverse: Blank

Versions: 1906-07/48.1 Brass
 1906-07/48.2 Brass on pin brooch



[1906-07/48.2]



Commemorative Medals – 1900s

1906-07/49



Diameter: 20.5 x 18 mm,
heart shape,
loop suspension

Metal: Brass with multi-
colour enamel

Rarity: R7



Obverse: Coloured representation of exhibition building; inscr above CHRISTCHURCH – / EXHIBITION 1906-1907.
Reverse: Blank

1906-07/50



Diameter: 32.5 x 24.5 mm,
irregular shape,
loop suspension

Metal: Gilt Brass, Brass

Rarity: R6



[1906-07/50.1]

Obverse: Exhibition building; inscr on ribbon below N.Z. INTERNATIONAL EXHIBITION 1906.7
Reverse: Blank

Versions: 1906-07/50.1 Gilt Brass
1906-07/50.2 Brass



[1906-07/50.2]





1906-07/51

Diameter: 34 x 15 mm,
New Zealand-shaped,
loop suspension

Metal: Brass

Rarity: R7

Maker: Stokes

Issue price: 1/-

[illustration unavailable]

Obverse: Inscr on NZ map elements: N.Z.I.E curving down on North Island / KIA ORA across in Cook Strait/ SOUVENIR reading upwards on South Island

Reverse: Blank

Note: No. 1906-07/52 has been retired.



1906-07/53

Diameter: 23 mm,
loop suspension
with crossbar and
rear clip

Metal: Brass, with
white & gold
enamel

Rarity: R7



[1906-07-53.1]

Obverse: NZIE monogram in centre circle. In outer circle inscr around above NEW ZEALAND INTERNATIONAL EXHIBITION and around below . 1906 . 7 .

Reverse: Blank

Versions: 1906-07/53.1 Suspender bar 31 x 11 mm, NATURAL / HISTORY
 1906-07/53.2 Suspender bar with EXECUTIVE COMMISSIONER

[illustration unavailable]

[1906-07/53.2]

[illustration unavailable]

1906-07/56



Diameter: 38 x 28 mm, loop suspension
Shield-shaped
Metal: Gold, Gold-plated sterling silver
Rarity: R6
Maker: George Coates & Co., Christchurch



[1906-07/56.1]

Obverse: Lyre on pedestal in wreath, FEB. 1907 above. Scrolls down L and R sides of shields blank for engraving. The whole surmounted by a ribbon on which N.Z.I.E / BAND CONTEST

Reverse: Blank for engraving, with maker's mark G.C. & C

Versions: 1906-07/56.1 Gold
1906-07/56.2 Gold-plated sterling silver



[1906-07/56.2]

[illustration unavailable]

Note: Nos. 1906-07/52, 54 and 55 have been retired.

1906-07/57

(-)



Diameter: 29 mm, pin-back
Kiwi in crescent shape
Metal: Silver, "Hollow Silver"
Rarity: R6



[1906-07/57.1]

Obverse: Kiwi to L on grassy ground between horns of crescent. Inscr on crescent N.Z. INTERNATIONAL EXHIBITION / CHRISTCHURCH / 1906.07

Reverse: Blank (pin-back)

Versions: 1906-07/57.1 Silver (hallmarked)
1906-07/57.2 "Hollow silver" (no hallmark)



[1906-07/57.2]



1906-07/58

(-)



Diameter: 20-20.5 mm (excluding loop), photo in flower-shaped surround with loop suspension
Metal: Brass?
Rarity: R7



Obverse: Photo of Exhibition building; inscr in front of building NEW ZEALAND / INTERNATIONAL EXHIBITION / CHRISTCHURCH / 1906-7; encased in brass surround

Reverse: Blank

Commemorative Medals – 1900s

	<p>1906-07/59 (-)</p>	
	<p>Diameter: 39 mm Metal: Aluminium Rarity: R6</p>	
<p>Obverse: Inscr in centre F.W. / TUCKER, / JEWELLER, / 225 HIGH / ST. / CHRISTCHURCH / N.Z.; inscr around NEW ZEALAND INTERNATIONAL EXHIBITION 1906-07 Reverse: Blank (mirror) Reference: See G#T16</p>		

	<p>1906-07/60 (-)</p>	
	<p>Diameter: 30 x 27 mm (heart-shaped) Metal: Bronze Rarity: R7</p>	
<p>Obverse: Circular frame in centre showing Exhibition building; in outer circle N.Z. INTERNATIONAL EXHIBITION around above; 1906-07 around below. Ornamental heart-shaped pattern around Reverse: Blank (pin-back)</p>		

DOMINION DAY MEDAL 1907

(Note: Actually struck and distributed in 1908)

Moller & Sons, Dunedin, were the successful tenderer for the striking of commemorative medal for Dominion Day. The tender called for 170,000 pieces which were to be distributed to school children on the first anniversary (26 September 1908) of the Dominion Day Declaration. The medals, it is recorded, were struck at the rate of 4,000 per day at the cost of 1 penny each. According to the *Otago Witness*, of 10 September 1908, "When completed the medals will be distributed as follows: – Auckland 37,000, New Plymouth 5700, Wanganui 15,200, Wellington 19,300, Napier 10,750, Blenheim 2450, Nelson 6800, Greymouth 2100, Hokitika 1350, Christchurch 22,900, Timaru 6100, Dunedin 22,000, Invercargill 10,750 – total, 163,000. The remainder 7000 – are to be sent to the Education Department, Wellington."

1907/1

[illustration unavailable]	Diameter: 27 mm, pierced Metal: Silver, Magnalium Rarity: Unknown; R1	[illustration unavailable]
----------------------------	---	----------------------------

[1907/1.1]

Obverse: Edward VII, bare head to R in circle, low crown above, the whole between crossed flags of New Zealand and the United Kingdom. Inscr around below EDWARD VII OF THE BRITISH DOMINIONS KING. Seven pearls in left arch of crown; bottom of flagpole between S and H

Reverse: Inscr PRESENTED TO / THE / CHILDREN / ATTENDING THE / SCHOOLS / OF THE / DOMINION between crossed fern leaves; 13 leaves to fern fronds (left frond, inner side including tip). Inscr around from 1:00 position NEW ZEALAND PROCLAIMED A DOMINION SEPTEMBER 26TH 1907 (no stop).

Versions: 1907/1.1 Silver
1907/1.2 Magnalium



[1907/1.2]





1907/1A
(-)



Diameter: 27 mm, pierced
Metal: Magnalium
Rarity: R2

Obverse: Like 1907/1 but 8 pearls in left arch of crown
Reverse: Like 1907/1, 13 leaves, no stop after 1907



1907/1B
(1907/4)



Diameter: 27 mm, pierced and unpierced
Metal: Magnalium
Rarity: R3

[1907/1B.1]

Obverse: Like 1907/1, low crown, 9 pearls to crown, large stars in flag
Reverse: Like 1907/1, 13 leaves, , no stop after 1907
Versions: 1907/1B.1 Pierced
 1907/1B.2 Unpierced



[1907/1B.2]



Commemorative Medals – 1900s



1907/2



Diameter: 27 mm, pierced
Metal: Magnalium
Rarity: R4

Obverse: Like 1907/1, low crown, 7 pearls
Reverse: Like 1907/1 but inscription commences above tips of fern fronds, 10 leaves to fern fronds. Stop after 1907



1907/2A
(1907/5)



Diameter: 27 mm, pierced
Metal: Magnalium
Rarity: R3

Obverse: Like 1907/1B, low crown, 9 pearls
Reverse: Like 1907/2 but 12 leaves of fern fronds, left frond to 19 of date, ends of stalks to M and between A and D. Stop after 1907



1907/2B
(1907/3)



Diameter: 27 mm, pierced
Metal: Magnalium
Rarity: R3

Obverse: Like 1907/1 but high crown, 8 pearls, flagpole over left leg of H of BRITISH, small stars in flag
Reverse: Like 1907/2, 10 leaves, no stop after 1907

OTAGO DIAMOND JUBILEE 1908



1908/1

Diameter: 27 mm, pierced
 Metal: White Metal,
 Aluminium
 Rarity: R2, R7?



[1908/1.1]

Obverse: Inscr * OTAGO * / * - * / DIAMOND / JUBILEE / * - * / 1848 - 1908

Reverse: Kiwi to L between flax and tree, mountains behind. Inscr around below IN COMMEMORATION

Versions: 1908/1.1 White metal

1908/1.2 Aluminium

Note: Silver reported but not confirmed

[illustration unavailable]

[1908/1.2]

[illustration unavailable]

AUCKLAND BAPTIST TABERNACLE SUNDAY SCHOOL JUBILEE 1908



1908/2

Diameter: 22.75 mm,
pierced
Metal: Gilt, Bronze
Rarity: R6, R7?



[1908/2.1]

Obverse: Baptist Tabernacle building. Inscr around above BAPTIST TABERNACLE and around below AUCKLAND

Reverse: Inscr JUBILEE in centre; -- / SUNDAY SCHOOL around above and 1908 around below, all in wreath

Versions: 1908/2.1 Gilt
1908/2.2 Bronze



[1908/2.2]



AUCKLAND INDUSTRIAL EXHIBITION 1908



1908/3

Diameter: 27 mm
 Metal: Lead,
 White Metal
 Rarity: R6, R7?



[1908/3.1]

Obverse: Inscr AUCKLAND / -.- / INDUSTRIAL / EXHIBITION / AUG. 1908. / - IN - / COMMEMORATION

Reverse: JOHN SWAN & CO / GENERAL ENGRAVERS / -.- / DIESINKERS / LETTER CUTTERS / - & - / NAME PLATE / SPECIALISTS / 18 WELLESLEY ST. W. / AUCKLAND / & DUNEDIN

Versions: 1908/3.1 Lead
 1908/3.2 White Metal



[1908/3.2]



VISIT OF THE USA FLEET AUCKLAND 1908



1908/4

Diameter: 30 mm, pierced & unpierced
 Metal: Silver, Aluminium, White metal
 Rarity: R6, R5, R4



[1908/4.1]

Obverse: Crossed US and NZ flags at top. Inscr below IN / COMMEMORATION / OF THE / AMERICAN FLEET'S / - VISIT TO THE - / DOMINION / - OF - / NEW ZEALAND / -.- / AUCKLAND. 1908

Reverse: Warship to L. H B in small letters below R

Versions: 1908/4.1 Silver
 1908/4.2 Aluminium
 1908/4.3 White metal





[1908/4.2]



[1908/4.3]



Commemorative Medals – 1900s

	1908/5	
	Diameter: 19.5 mm, loop suspension	
	Metal: Silver	
	Rarity: R4	
Obverse: Crossed NZ and US flags in centre. Inscr around TO COMMEMORATE VISIT OF AMERICAN FLEET .		
Reverse: Warship in centre. Inscr around above AUCKLAND NEW ZEALAND and around below . 1908 .		



1908/6

Diameter: 47 x 34 x 5 mm,
shield shape with
pin-back
suspension bar,
with or without
ribbon; pin-back
also noted

Metal: Gilt

Rarity: R6

[1908/6.1]

Obverse: At top of shield inscr VISIT OF; in diagonal bar across shield U.S.A. NAVAL FLEET; ships at sea above R; anchor and bollard with ropes below L. Between anchor and bollard inscr TO / NEW ZEALAND and 1908 at base

Reverse: Blank

Note: On bar SOUVENIR

Versions: 1908/6.1 Straight bar with ribbon

1908/6.2 Curved bar, no ribbon

1908/6.3 Pin-back (*Note: uncertain if original or done later*)

[1908/6.2]

Commemorative Medals – 1900s



[1908/6.3]

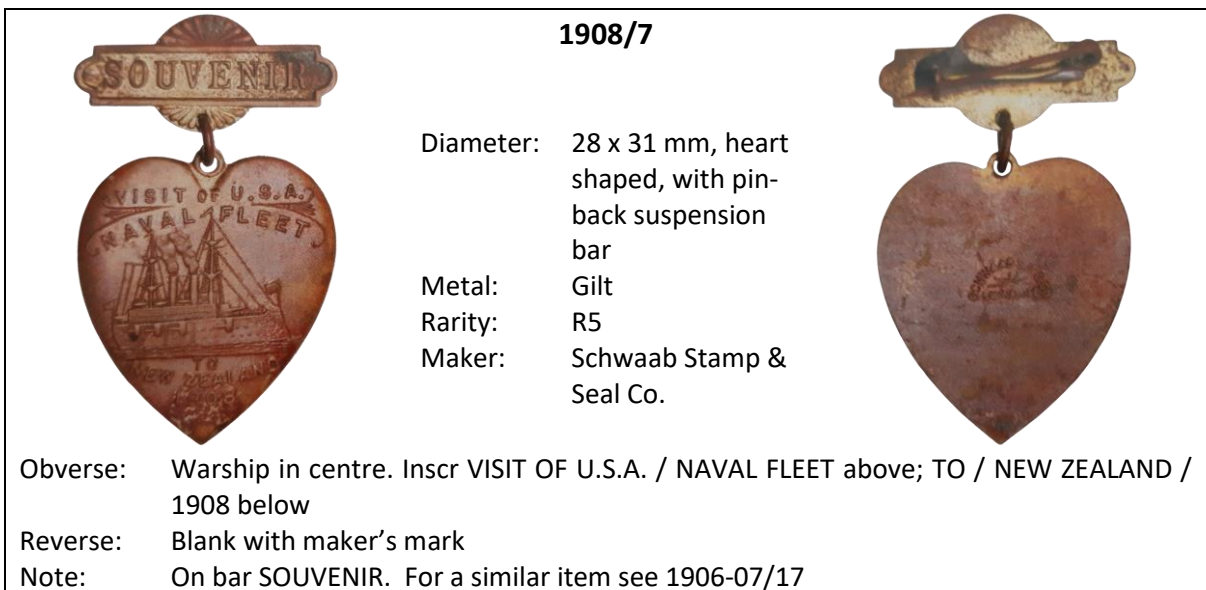

1908/7

Diameter: 28 x 31 mm, heart shaped, with pin-back suspension bar
Metal: Gilt
Rarity: R5
Maker: Schwaab Stamp & Seal Co.

Obverse: Warship in centre. Inscr VISIT OF U.S.A. / NAVAL FLEET above; TO / NEW ZEALAND / 1908 below

Reverse: Blank with maker's mark

Note: On bar SOUVENIR. For a similar item see 1906-07/17

1908/8



Diameter: 25.5 x 27 mm,
pin-back;
irregular shape
(circular medal
between crossed
flags; bar
attached at base
with ribbon
below)



Metal: Silver
Rarity: R6

Obverse: In centre of medal AUG / --- . --- / 1908; inscr around RECEPTION COMMITTEE . Bar engraved AUCKLAND . N.Z

Reverse: Blank with SILVER incuse, pin-back

Note: The records state that the Reception Committee had 17 members who were responsible for organising all the events and hospitality for visiting crew.



[With ribbon]



MARLBOROUGH JUBILEE 1909

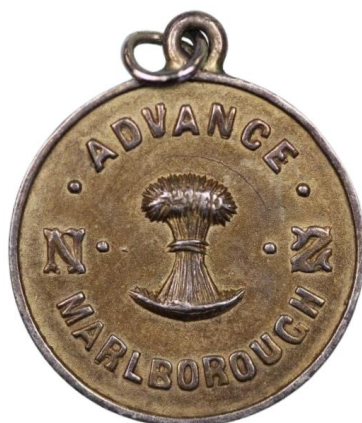

1909/1

Diameter: 17 mm, loop suspension
Metal: Silver
Rarity: R6



[1909/1.1]

Obverse: Wheat sheaf in centre; N . at L; . Z at R. Inscr around above . ADVANCE . and around below MARLBOROUGH

Reverse: Inscr . NOVEMBER . in centre with ornamental designs above and below. Inscr around above . JUBILEE . / and around below .. 1909 ..

Versions: 1909/1.1 Silver
1909/1.2 Silver gilt



[1909/1.2]



1909/1A
(-)

Diameter: 26x18 mm, loop suspension
Metal: Silver
Rarity: R7



Obverse: Stock medal with shield element in centre engraved 1859 / 1909

Reverse: Birmingham 1904 hallmarks at top, field engraved MARLBOROUGH / JUBILEE (diagonal)

Note: No. 1909/2 has been deleted as a Scottish issue.

List of Makers & Manufacturers

Medallists and Manufacturers

Bock & Sons Wellington	Established in 1890 by W.R. Bock (1847-1932). General engravers, die sinkers, badge makers, medallists and illuminators. Closed in 1987.
Bridgland & King Melbourne	<i>fl.</i> 1900-1920. Located at 289 Little Lonsdale Street, Melbourne
G. Coates & Co. Christchurch	Established in Nelson in 1851, relocated to Christchurch 1861. Manufacturing jewellers, watchmakers, opticians, etc.
W.J. Dingley Birmingham	Silversmiths; subsequently associated with Toye, Kenning & Spencer
Emil Fuchs	Born in Vienna in 1866, based in London 1897-1915. Died 1929. Responsible for various stamp and medal designs internationally, in addition to works in other media (paintings, statues).
Henry Grueber & Co. London	Designer, die-sinker and maker of aluminium medals. <i>fl.</i> 1891-1917
John Hislop 74 Princes Street, Dunedin	Watchmaker, Jeweller and Silversmith (Liverpool 1832 – Dunedin 1900). The business appears to have continued after his death.
Adolph Kohn Queen Street, Auckland	Jeweller in Christchurch, Whanganui and lastly Auckland; died 1910
L. Chr. Lauer Nuremberg, Germany	A well known family of manufacturers. The firm was established in the 18 th century and under the name L. Chr. Lauer Nürnberg made many tokens, counters, medals and miniature imitations of British coins, as well as supplying blanks and stock medals for third-party use.

List of Makers & Manufacturers

<p>C. Moller & Sons Dunedin</p> <p>Brandwell Moller, 24 McBride Street, South Dunedin +64-3-477-6332 brandwell.moller@xtra.co.nz www.brandwellmoller.co.nz</p>	<p>Established in Dunedin in 1862. Subsequently part of Hanson & Berry in Auckland, then acquired by an engraving firm in Dunedin in 1980 and trading under the name Brandwell Moller Ltd.</p>
<p>Moller & Young Christchurch</p> <p>Moller-Young (NZ) Ltd, 383 No 10 Road, Swannanoa RD6, Rangiora 7476 PO Box 818, Rangiora 7440 03 312 0310 sales@molleryoung.co.nz www.molleryoung.co.nz</p>	<p>Established in Christchurch in 1897 as a branch of C. Moller & Sons. After five generations in the Moller family the company was sold to a new owner and now trades as Moller-Young (NZ) Ltd.</p>
<p>Schwaab Stamp & Seal Co. Milwaukee</p> <p>Schwaab Inc., 12855 W Lisbon Rd Brookfield WI 53005, United States. www.schwaab.com</p>	<p>Now Schwaab Inc. Founded in 1881.</p>
<p>Stokes Melbourne, VIC, and Riverwood, NSW</p> <p>Stokes Badges, PO Box 779 Riverwood NSW 2210, Australia +61-2-8525 7676 sales@stokesbadges.com.au</p>	<p>Founded 1856. Later Stokes & Martin, Thomas Stokes & Sons, and now Stokes Badges. Prominent manufacturer responsible for producing many tradesmen's tokens and medals for Australia and New Zealand.</p>
<p>John Swan & Co. Ltd Dunedin and Auckland</p> <p>366 Moray Place, Central Dunedin Dunedin 9016 +64 3 477 2064 orders@johnswan.co.nz www.johnswan.co.nz</p>	<p>Founded 1878. Auckland branch operated for 20 years in the early 20th century. Last family owner sold company to new owner in 2015.</p>
<p>Anton Teutenberg</p>	<p>Born near Cologne in 1840 and settled in NZ in 1866. A prolific maker of medals, decorations, seals, etc. He retired during WW1 and his business was sold.</p> <p>The definitive reference work is Teutenberg, A Master Engraver & His Work, by John Cresswell and James Duncan (2007), ISBN 0-473-07251-3</p>

List of Makers & Manufacturers

<p>Charles Wright Ltd Edgware, Middlesex, UK</p>	<p>Established in Clerkenwell, 1867. Moved to Edgware 1900. Known as Wright & Son Ltd from the 1920s. Produced vast numbers of medals for returned soldiers from WW1. Also active in stamping vehicle number plates and gave its name to a font used on these. The company was wound up in the 1970s.</p>
---	---

Rarity Scale

To assist the collector in determining the possibility of obtaining any of the listed commemorative pieces, a rarity scale has been included. This is based upon personal collectors and dealers combined knowledge.

No estimates of value have been included as this publication is intended as a numismatic record not a price catalogue. In some respects, it is unnecessary as collectors and dealers already have a market worth and appreciation of commemoratives and will pay accordingly.

As a general rule rarity does not automatically mean that a medallion is highly valuable. In numismatics, prices depend on additional factors to scarcity such as condition and demand. Also, handsome medallions commemorating events or occasions of importance can be worth more than equally or scarcer pieces issued for unimportant or obscure events. For example 1865/1 or 1872/1 both with a R5 rarity are more valuable than 1882/18 with a R6 rarity or 1906-07/39 with an even higher R7.

Also, price quotes quickly become outdated.

R1	very common	
R2	common	
R3	normal scarce	
R4	scarce	
R5	rare	(estimated 11 to 25 known)
R6	very rare	(estimated 4 to 10 known)
R7	extremely rare	(estimated 1 to 3 known)

The rarity figures provided are the compilers' best estimates in each case and are not definitive. The editors would be interested to learn of any known mintage figures or confirmed known quantities that suggest any of the stated estimates should be changed.

About the Authors ...

Martin Purdy FRNSNZ

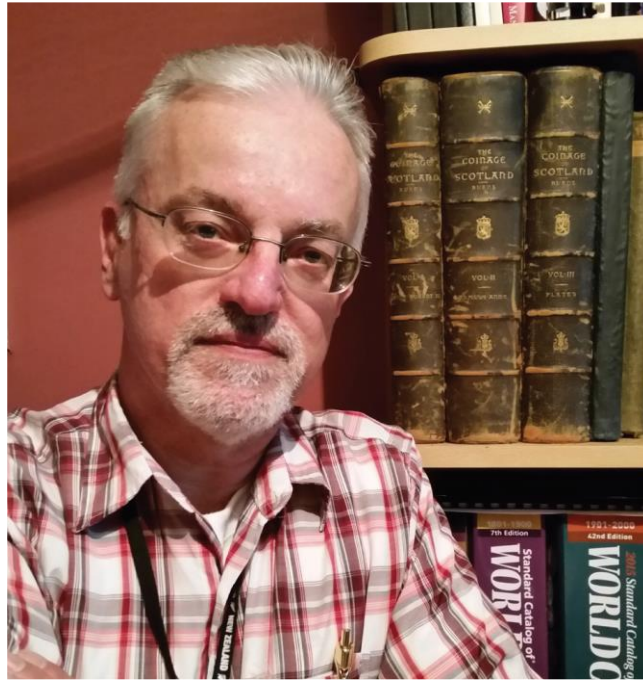

Martin arrived in New Zealand as a five-year-old in 1970 with a matchbox full of British coins that eventually formed the basis for his collection.

The discovery of coins with legends in foreign languages and different alphabets led him to a career as a translator, though he has remained an active collector and student of coins and medals for 50 years.

A former President of both the Royal Numismatic Society of New Zealand (2003-2006) and the Wellington Coin Club (1989-1994), and Secretary of the RNSNZ (1990-1997), he was involved in editing and publishing the Society's Journal for over twenty-five years, becoming a Fellow of the Society in 2003.

Subsequently, he collaborated with Hamish MacMaster on larger-scale undertakings such as the two editions of the catalogue of post-1940 Commemorative Medals published in 2009 and 2014, and the first and second editions of the Catalogue of NZ Challenge Coins (2011, 2016). In collaboration with Rodney, he compiled and published a supplement to the 2nd edition in May 2019.

A new initiative is this chapter-by-chapter electronic publication of a new edition of Leon Morel's catalogue of pre-1940 medallic commemoratives, with an electronic third edition of the "MacMaster" post-1940 catalogue being prepared in parallel.

A keen vintage car enthusiast, Martin also edits Sphinx-NZ, the magazine of the Armstrong Siddeley Car Club in NZ.

Jason Gray



Jason started to take an interest in numismatics after being shown a 1993 kingfisher design \$2 coin by his grandfather as a teenager. But it was not until many years later that he started collecting coins himself, joining the Manawatu Numismatic Society in 2007. His interests extended to medals and tokens. However, his passion is in the small details of coin errors, and this is documented on his website coinerrors.nz.

Now Jason works on discovering, photographing, and cataloguing New Zealand coins, tokens, and commemorative medals, and has contributed to the medal and challenge coin catalogues in this series since 2014.

He is a keen kayak angler and loves going on adventures with the family.

Rodney Hall



Rodney was born in an England still gripped by food rationing. At 18 months, he travelled by plane (BOAC Argonaut) via the Middle East and Ceylon to Singapore (a three-day trip with flying only during daylight hours).

He spent the next 13 years overseas in Malaya, Singapore and finally on the island of Zanzibar in East Africa, and has fond memories of sea, sand, and sun on the beaches there, with boarding school just a plane, train, and bus ride away in Kenya.

It was during these years in East Africa that Rodney started collecting world coins, garnered by his father who travelled extensively around the world as a fisheries scientist.

After returning by ship (the P&O liner Chusan) via Cape Town to England, he could not wait to leave again, and in 1978 with a young family in tow emigrated to New Zealand.

Along with his interest in NZ challenge coins, Rodney also collects NZ Geocoins, NZ Pathtags and Philippine challenge coins, and is actively researching and gathering data for various electronic catalogues, including monthly online updates to the standard reference on NZ Challenge Coins.

Hamish MacMaster FRNSNZ



Hamish was born in 1961 in Christchurch, where he developed an early and passionate interest in coins and medals.

Hamish has been a member of the Royal Numismatic Society of NZ for over twenty-five years, serving as its Assistant Secretary (2003) and Secretary (2009-2013, 2022-), and is currently a Vice President (2014-).

In addition to regular articles for the Society's Journal, he has written, in collaboration with Martin Purdy, the 2009 Catalogue of New Zealand Commemorative Medals 1941-2007, and its updated and expanded 2nd edition in 2014; and the 2011 New Zealand Challenge Coins: A Catalogue, and its second edition in 2016.

In 2010 he became a Fellow of the Society.

Pursuing a diplomatic career in the Ministry of Foreign Affairs and Trade, Hamish served as New Zealand's Ambassador to the Islamic Republic of Iran accredited also to Afghanistan and Pakistan (2004-2009) and was subsequently Ambassador to the Kingdom of Saudi Arabia (2015), resident in Riyadh and also accredited to Bahrain, Kuwait, and Oman. In 2016 his list of (non-resident) accreditations was expanded when he was appointed as New Zealand's first ever Ambassador to the Republic of Yemen. Hamish returned from serving again as Ambassador to Iran in 2021.

Notes / New Additions



[1906-07/15.1]

ISBN 978-1-991108-55-5



9 781991 108555

